

# *PE85Ntt BUILDING*

## *ULAZNA VRATA I SKRIVENO KRILO*





PROFILI

Kod Codice Code	Presjek Sezione Cross Section		Težina	Perimetar	Vidljiva	Jx	Wx	Jy	Wy
			Peso Weight	Perimetro Perimeter	površina Sup. in Vista Exposed surface				
			Kg/m	mm	mm	cm <sup>4</sup>	cm <sup>4</sup>	cm <sup>4</sup>	cm <sup>4</sup>
PE85202			0841						
				1.860	331.1	133.1	58.51	12.25	20.48
PE85206			0839						
				1.967	345.1	147.1	65.19	13.72	29.49
PE85212			0843						
				1.827	303.5	129.1	53.19	12.70	27.69
PE85214			0844						
				2.010	363.5	140.0	66.14	15.32	35.64
PE85235			0846						
				2.141	386.7	114.5	24.72	6.50	19.11
PE85139			0820						
				1.607	370.5	114.5	49.8	11.5	12.5
PE85241			0629						
				0.988	370.5	91.17	1.15	1.0	16.56
			0850						
			0851						



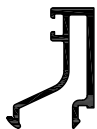
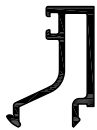
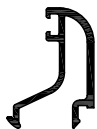
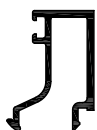
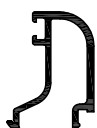

**PROFILI**

Kod Codice Code	Presjek Sezione Cross Section		Težina Peso Weight  Kg/m	Perimetar Perimetro Perimeter  mm	Vidljiva površina Sup. in Vista Exposed surface mm	Jx  cm <sup>4</sup>	Wx  cm <sup>4</sup>	Jy  cm <sup>4</sup>	Wy  cm <sup>4</sup>



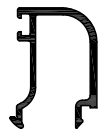
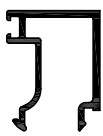
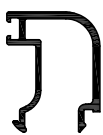
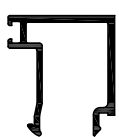
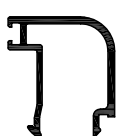

PROFILI

Kod Codice Code	Presjek Sezione Cross Section	Težina Peso Weight Kg/m	Perimetar Perimetro Perimeter mm	Vidljiva površina Sup. in Vista Exposed surface mm	Jx cm <sup>4</sup>	Wx cm <sup>4</sup>	Jy cm <sup>4</sup>	Wy cm <sup>4</sup>
PR50553		0.258	151.12	31.1				
PR50554		0.260	151.84	32.1				
PR50555		0.248	146.01	28.8				
PR50556		0.266	154.02	35.1				
PR50557		0.255	148.35	31.88				
PR50558		0.271	155.47	37.1				
PR50559		0.259	149.81	33.88				
PR50560		0.275	156.92	39.1				



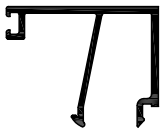

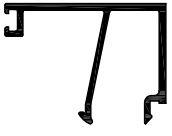
PROFILI

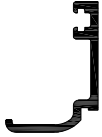
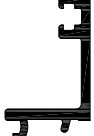
Kod Codice Code	Presjek Sezione Cross Section	Težina Peso Weight Kg/m	Perimetar Perimetro Perimeter mm	Vidljiva površina Sup. in Vista Exposed surface mm	Jx cm <sup>4</sup>	Wx cm <sup>4</sup>	Jy cm <sup>4</sup>	Wy cm <sup>4</sup>
PR50561		0.263	151.26	35.88				
PR50562		0.298	170.22	42.1				
PR50563		0.287	164.55	38.88				
PR50564		0.306	173.09	45.1				
PR50565		0.294	167.42	41.88				
PR50566		0.322	182.16	47.1				
PR50567		0.301	176.49	43.88				
PR50568		0.342	192.16	52.1				

PROFILI

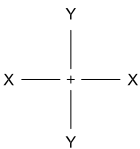
Kod Codice Code	Presjek Sezione Cross Section	Težina Peso Weight Kg/m	Perimetar Perimetro Perimeter mm	Vidljiva površina Sup. in Vista Exposed surface mm	Jx cm <sup>4</sup>	Wx cm <sup>4</sup>	Jy cm <sup>4</sup>	Wy cm <sup>4</sup>
PR50569		0.330	176.49	48.88				
PR50570		0.354	198.16	55.1				
PR50571		0.341	192.49	51.88				
PR50572		0.362	202.16	57.1				
PR50573		0.350	196.49	53.88				
PR50574		0.211	104.50	26.60				
PR50576		0.218	103.56	27.10				

PROFILI

Kod Codice Code	Presjek Sezione Cross Section		Težina Peso Weight  Kg/m	Perimetar Perimetro Perimeter  mm	Vidljiva površina Sup. in Vista Exposed surface mm	Jx  cm <sup>4</sup>	Wx  cm <sup>4</sup>	Jy  cm <sup>4</sup>	Wy  cm <sup>4</sup>
PR50550			0.158	49.06	14.5				
PR58538			0.206	105.3	20.9				
PR58543			0.211	80.3	28.0				

PROFILI OKVIRA

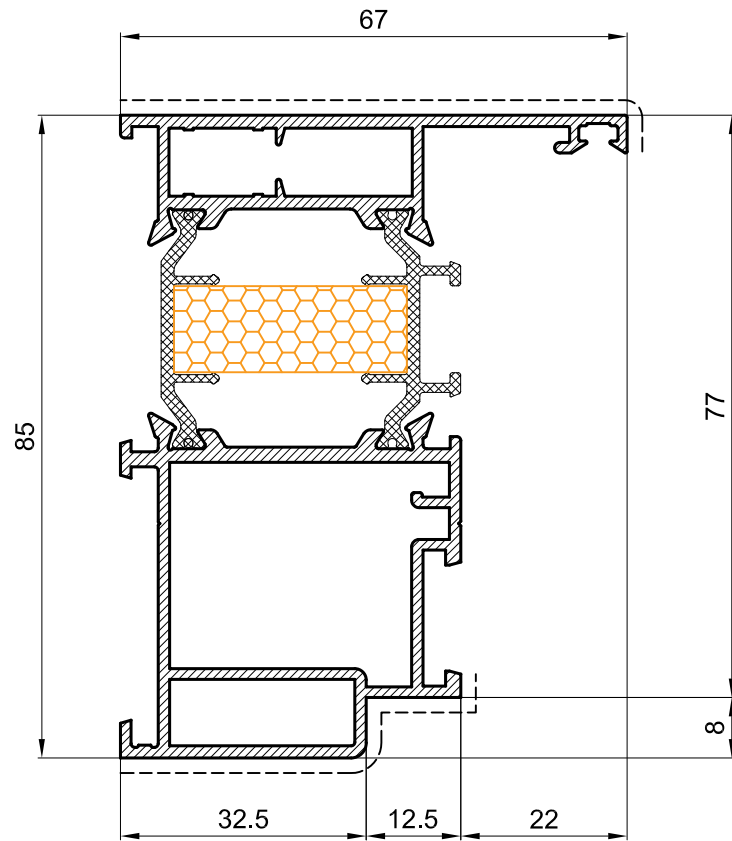

PE85202 1.860 Kg/m

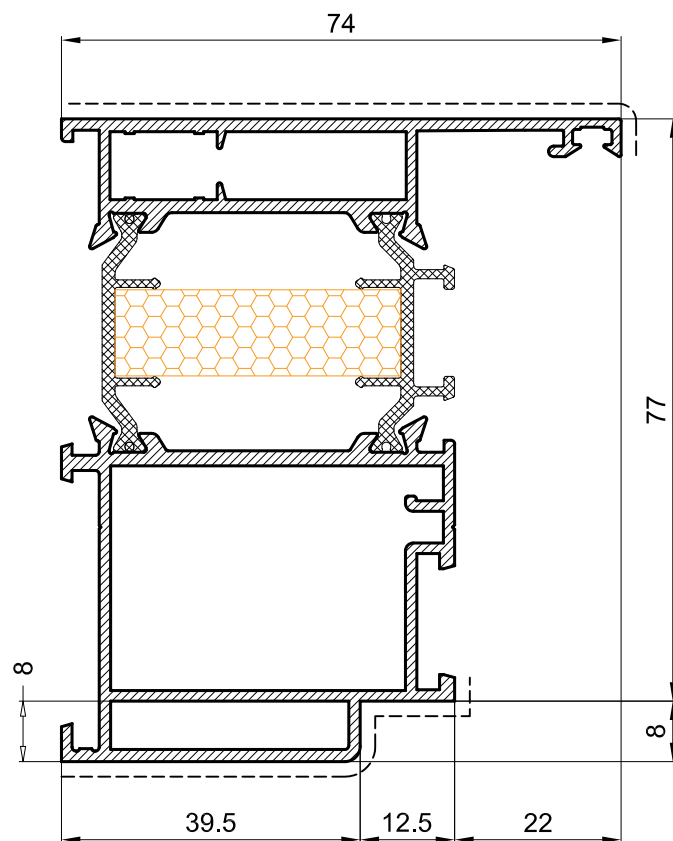

PE85206 2.018Kg/m

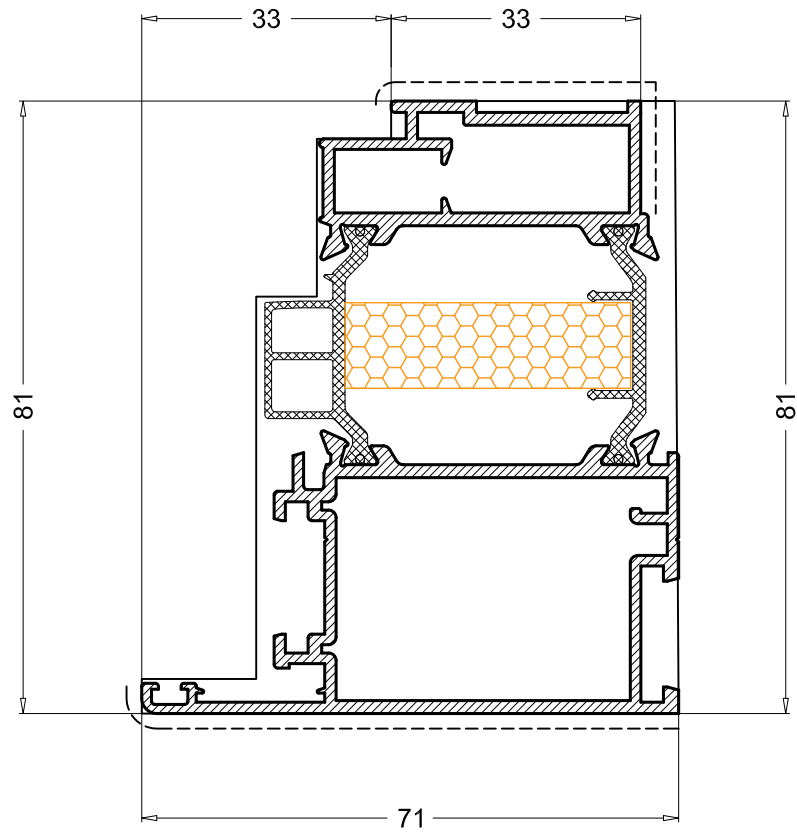

**PROFILI KRILA**

PE85212 1.827 Kg/m

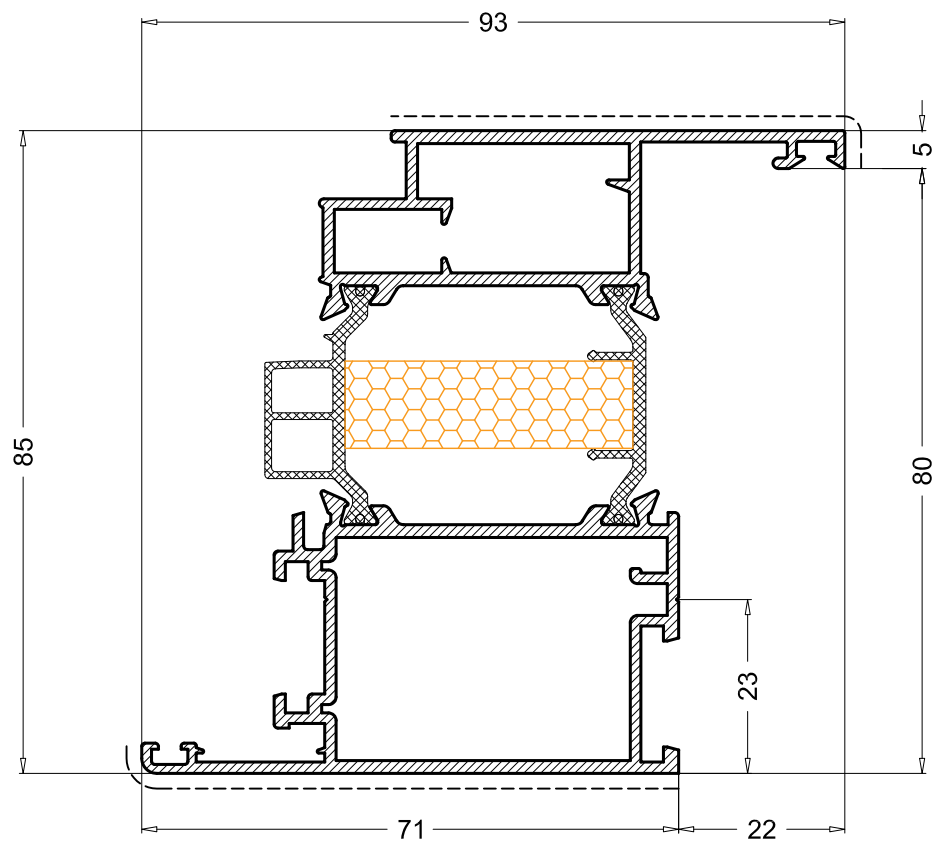

PE85214 2.046 Kg/m

PROFILI KRILA

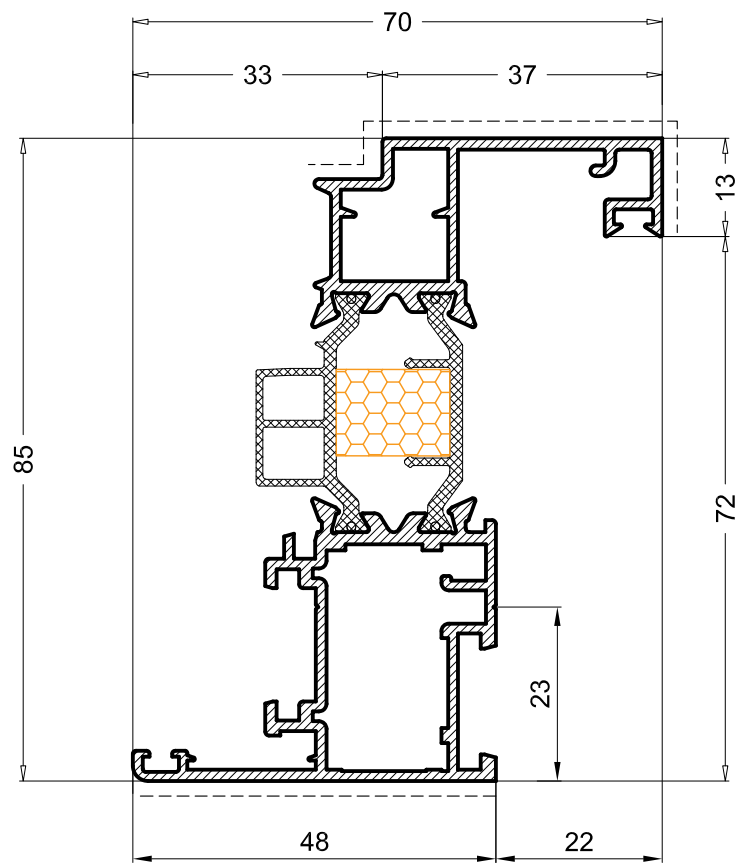

PE85139 1.607 Kg/m

PROFILI PREČKE I PRAGA

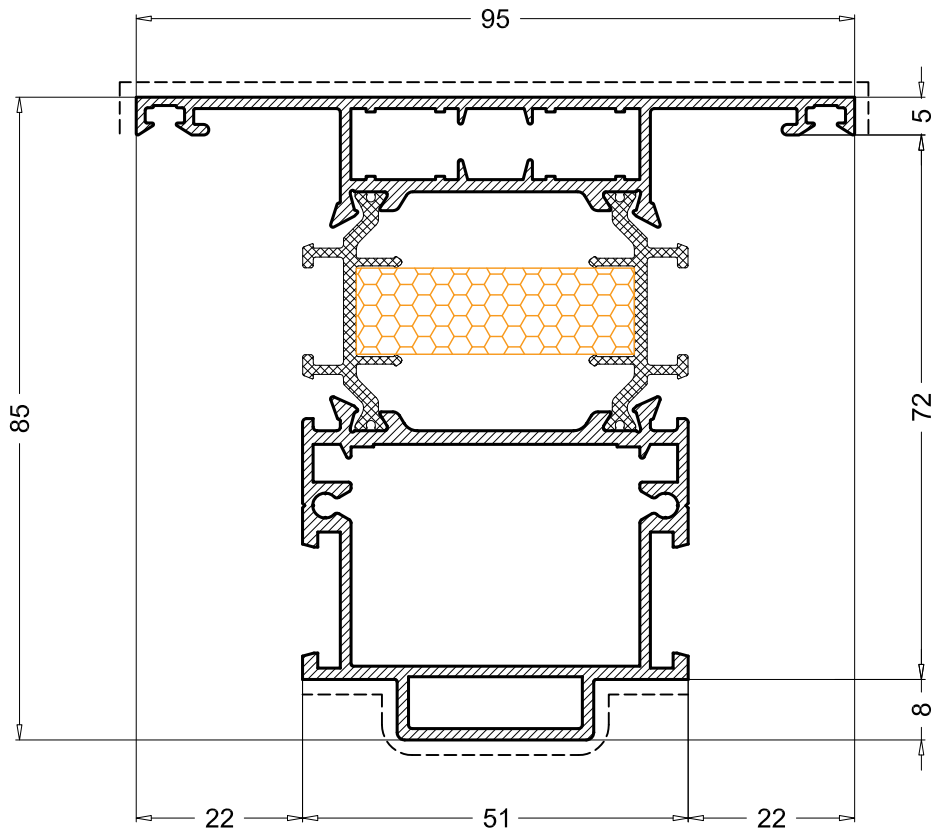

PE85235 2.142 Kg/m

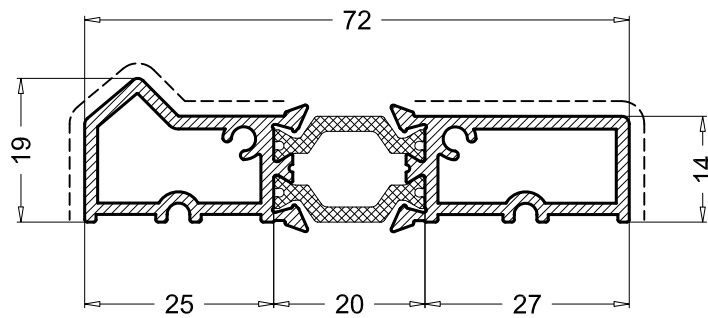

PE85241 0.988 Kg/m

DODATNI PROFILI

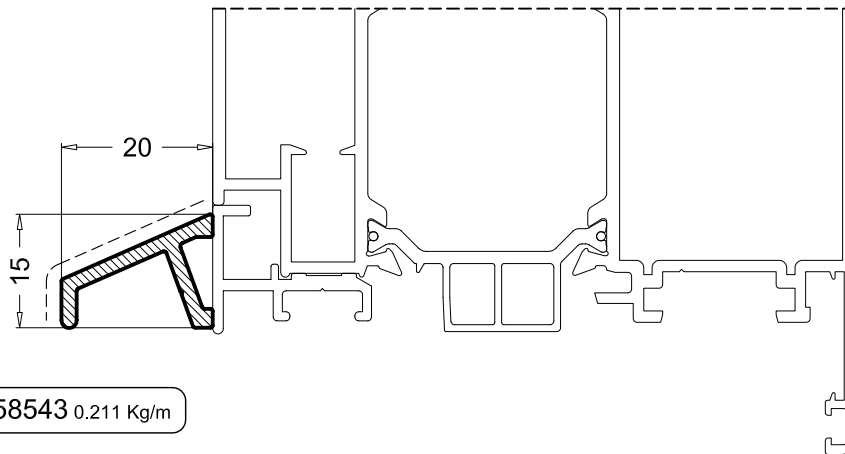

PR58543 0.211 Kg/m

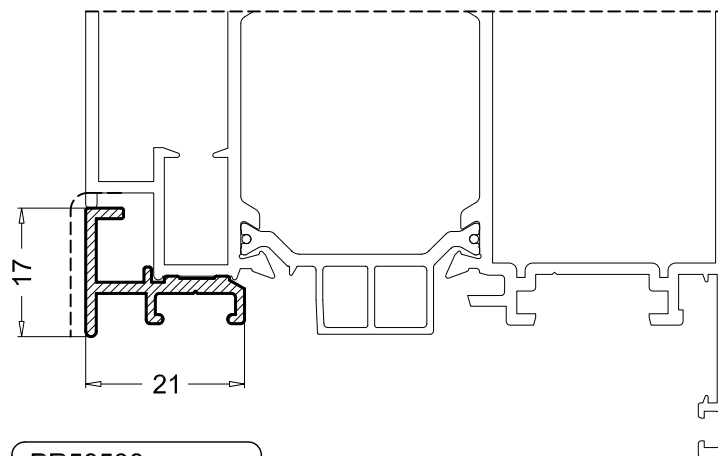

PR58538 0.206 Kg/m

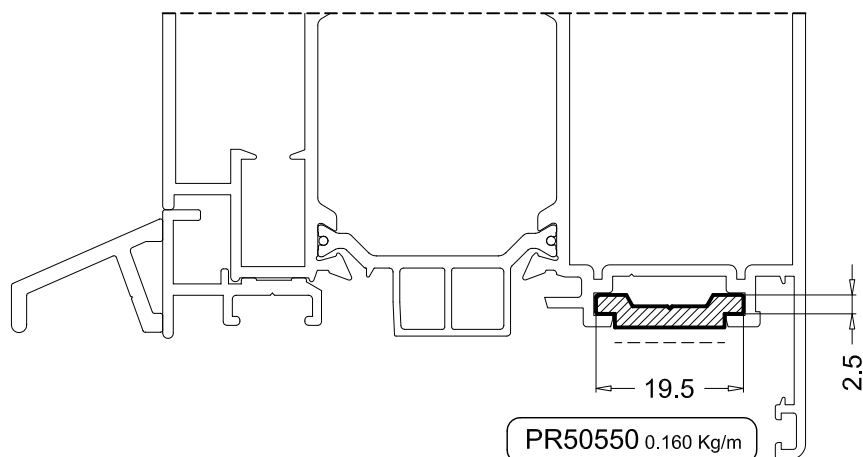

PR50550 0.160 Kg/m

**PROFILI LAJSNE**

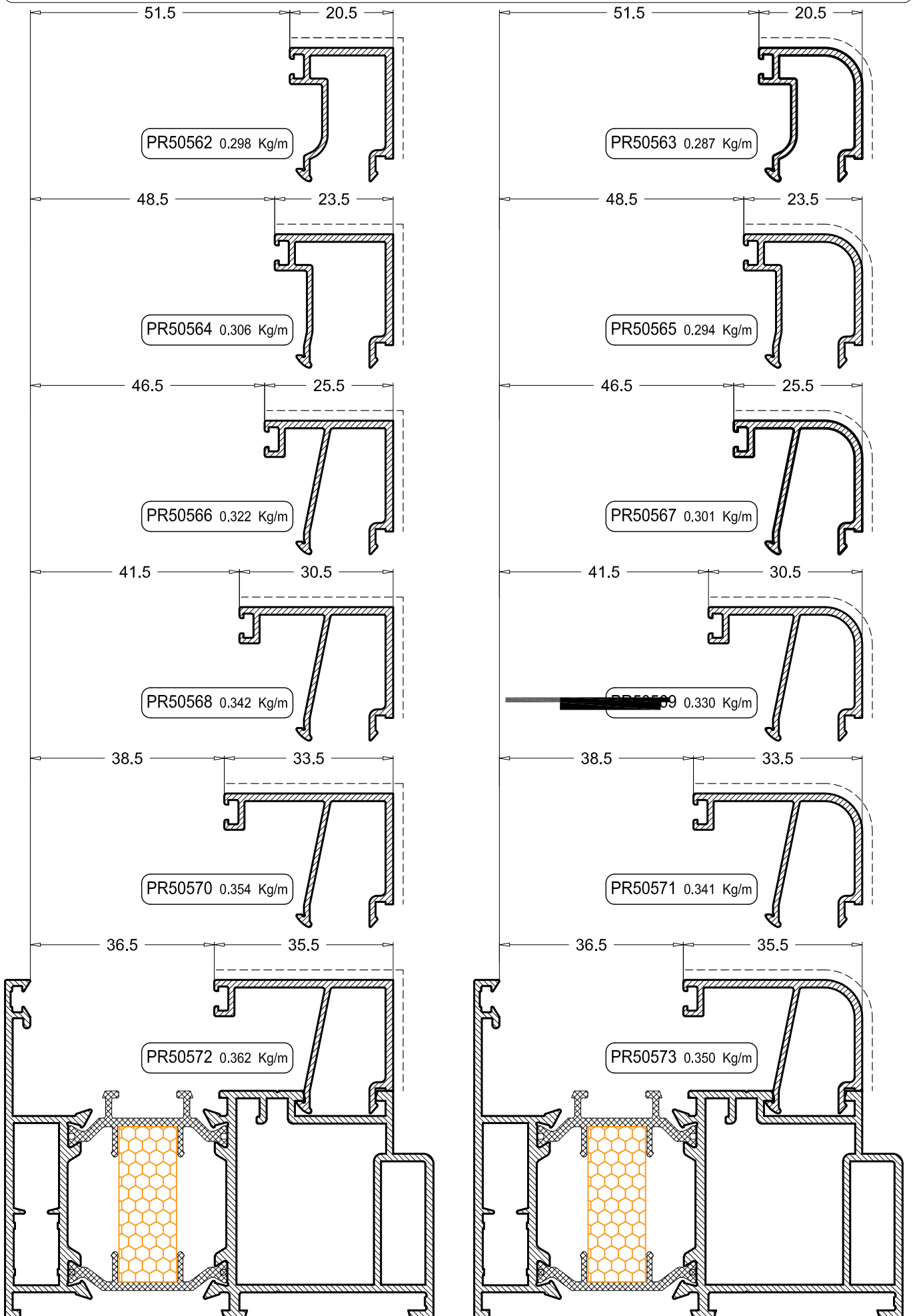

**PROFILI LAJSNE**

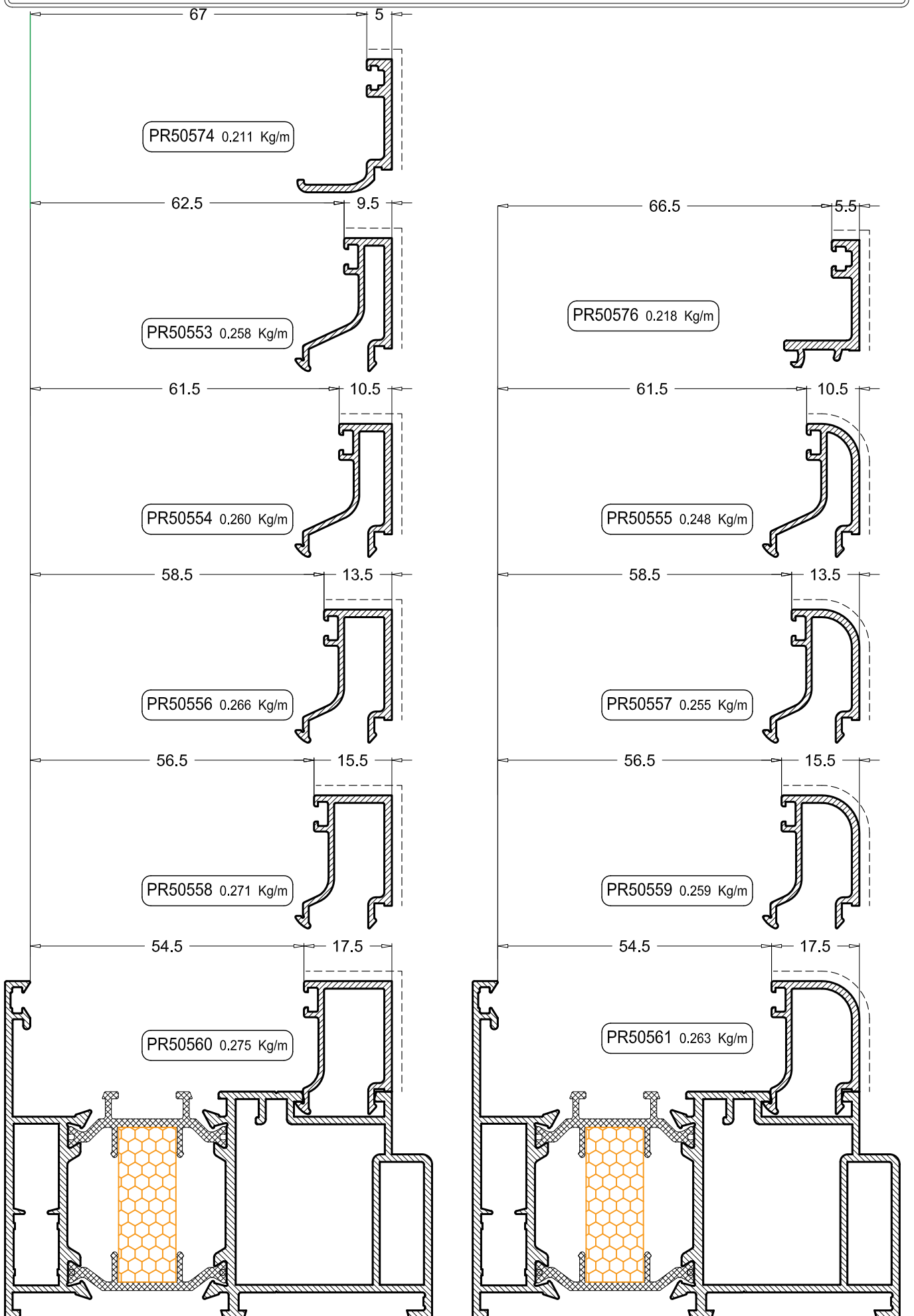

### PROFILI LAJSNE

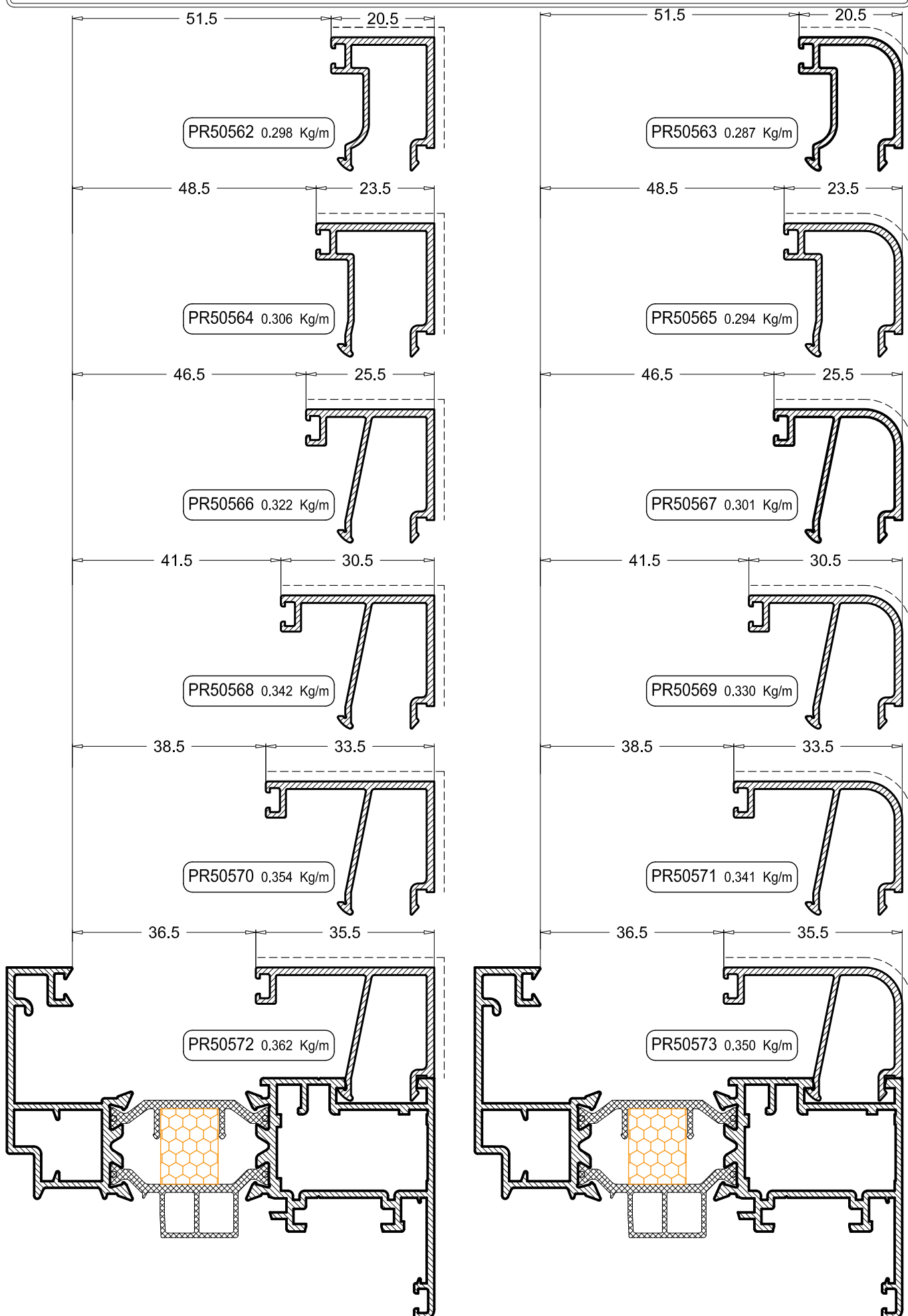

PROFILI LAJSNE

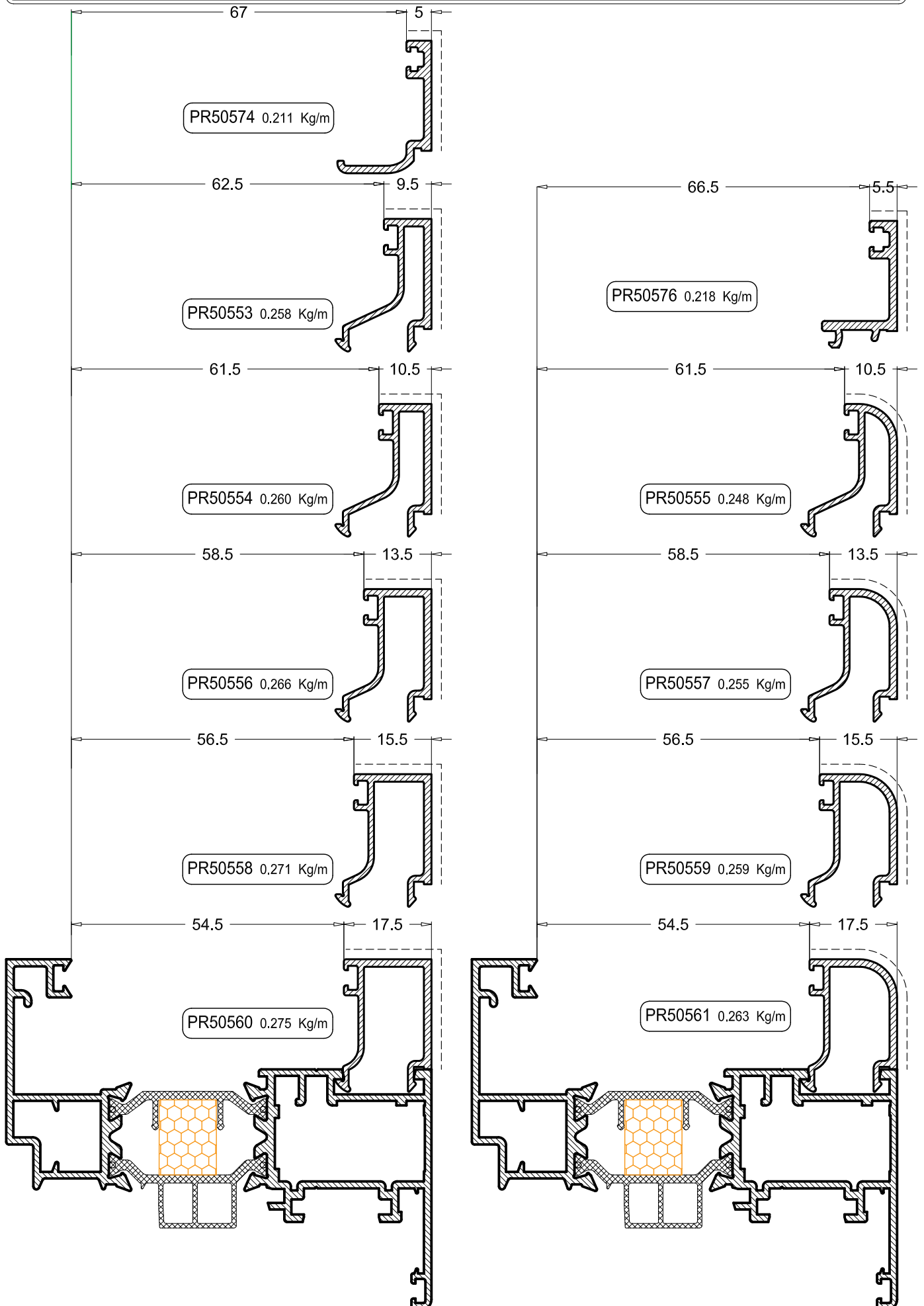



## PROFILI LAJSNE

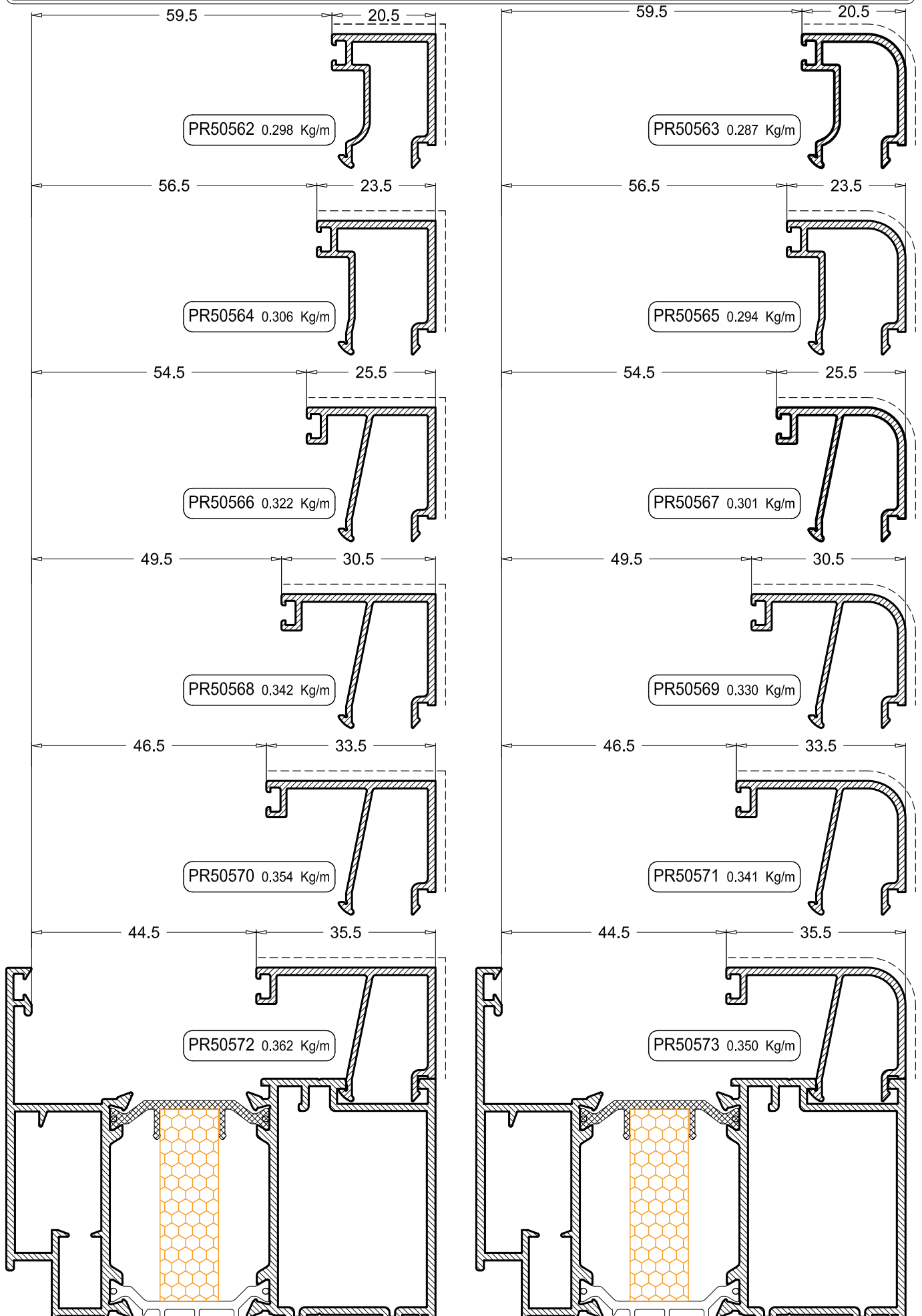

## PROFILI LAJSNE

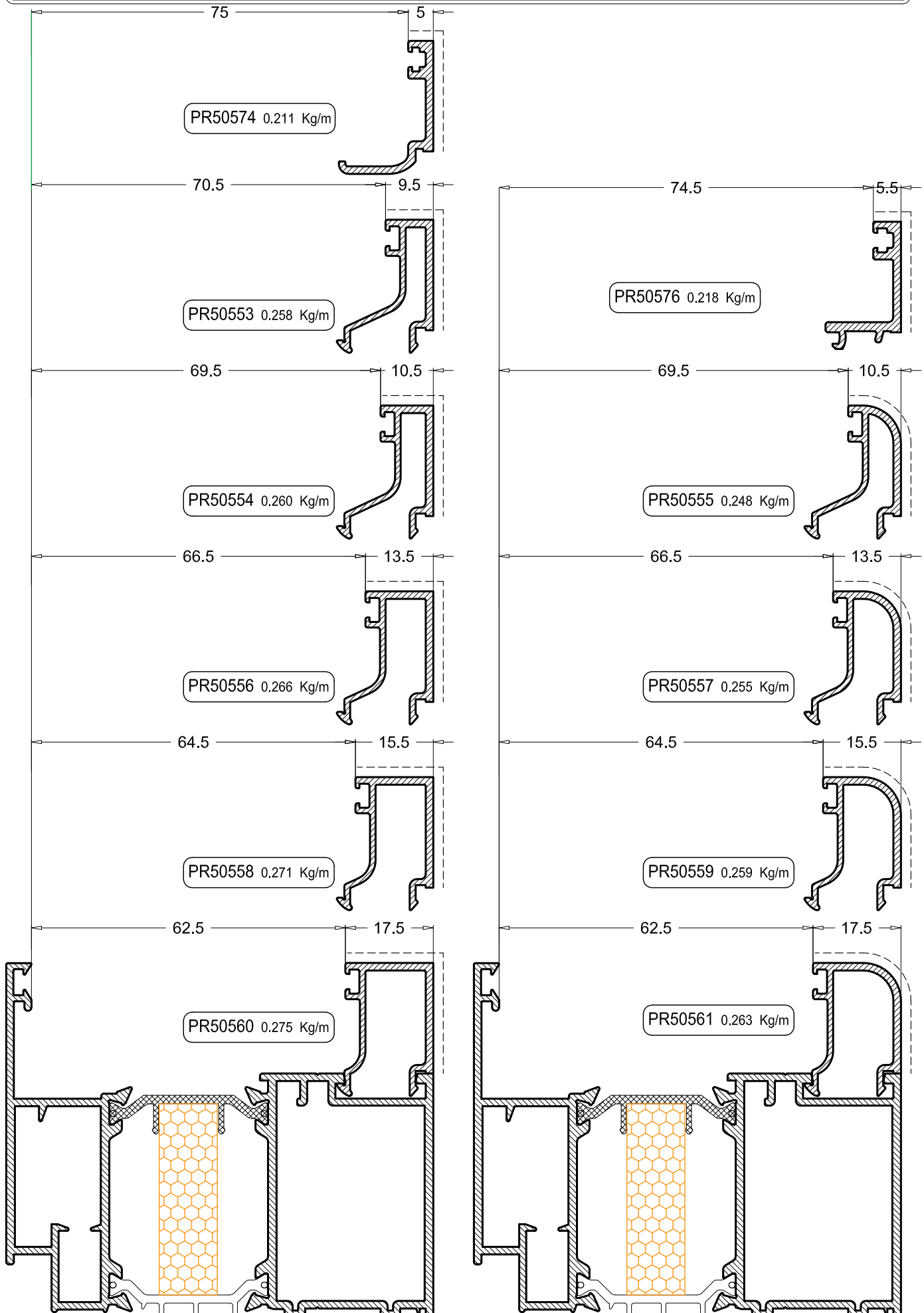

Jednokrilna panel vrata - Široki štok

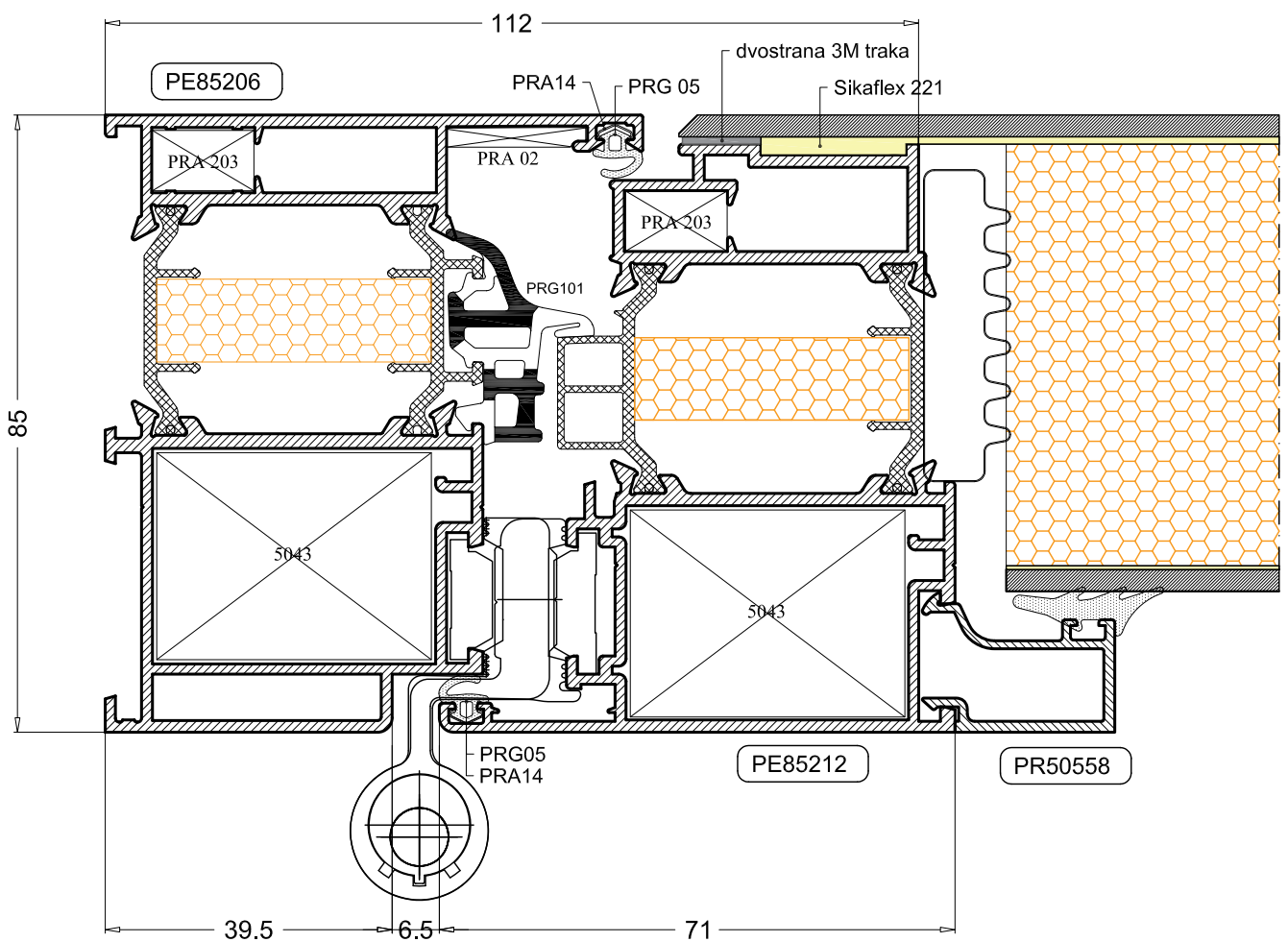
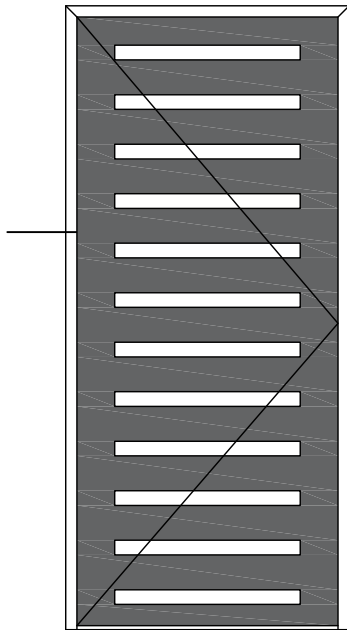

Jednokrilna panel vrata - Široki štok

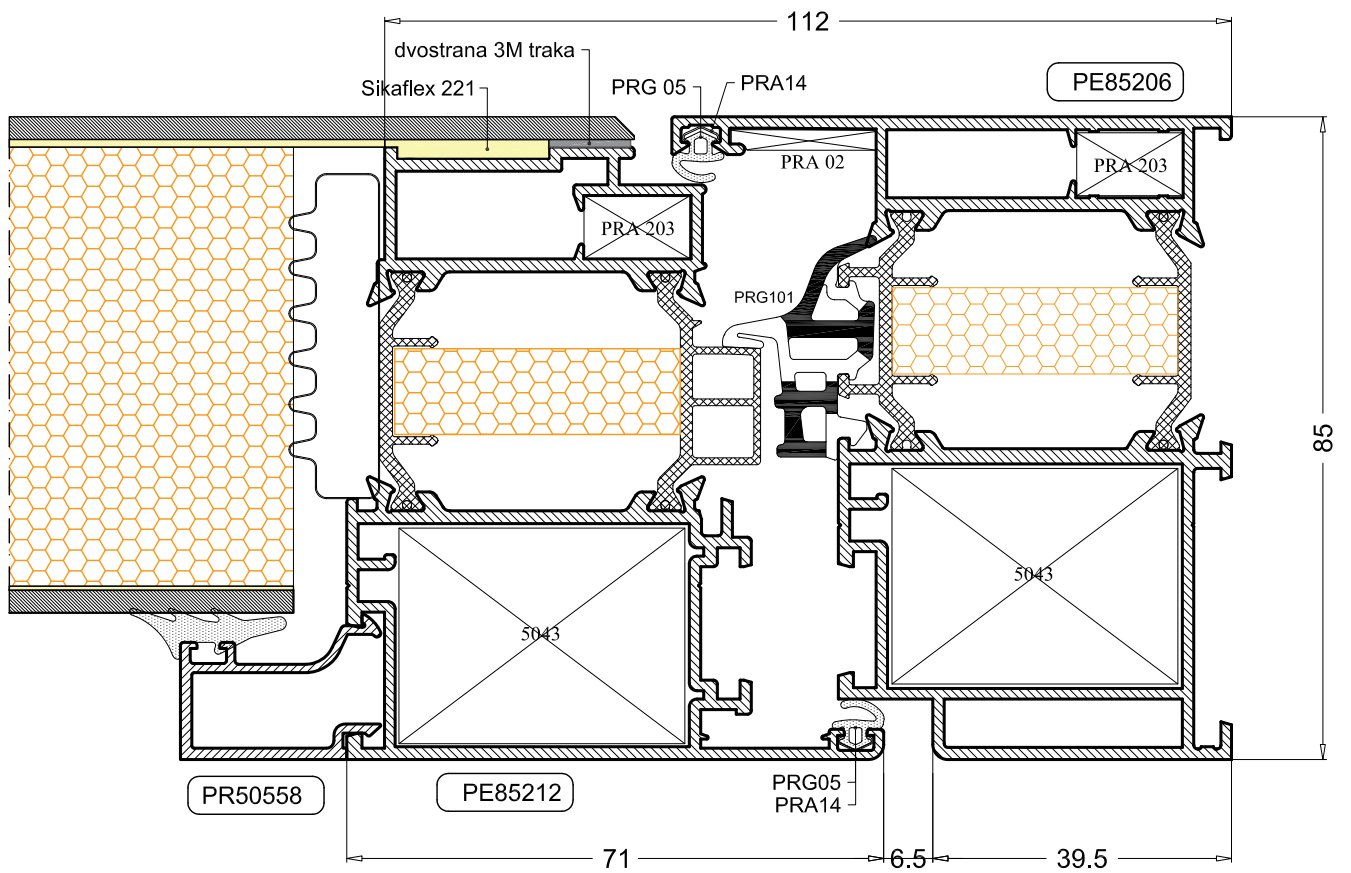
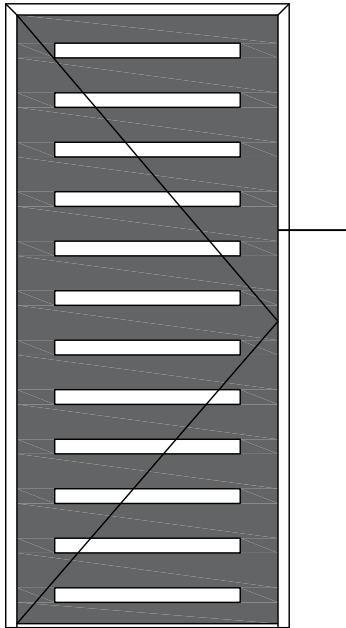

Jednokrilna panel vrata - Široki štok

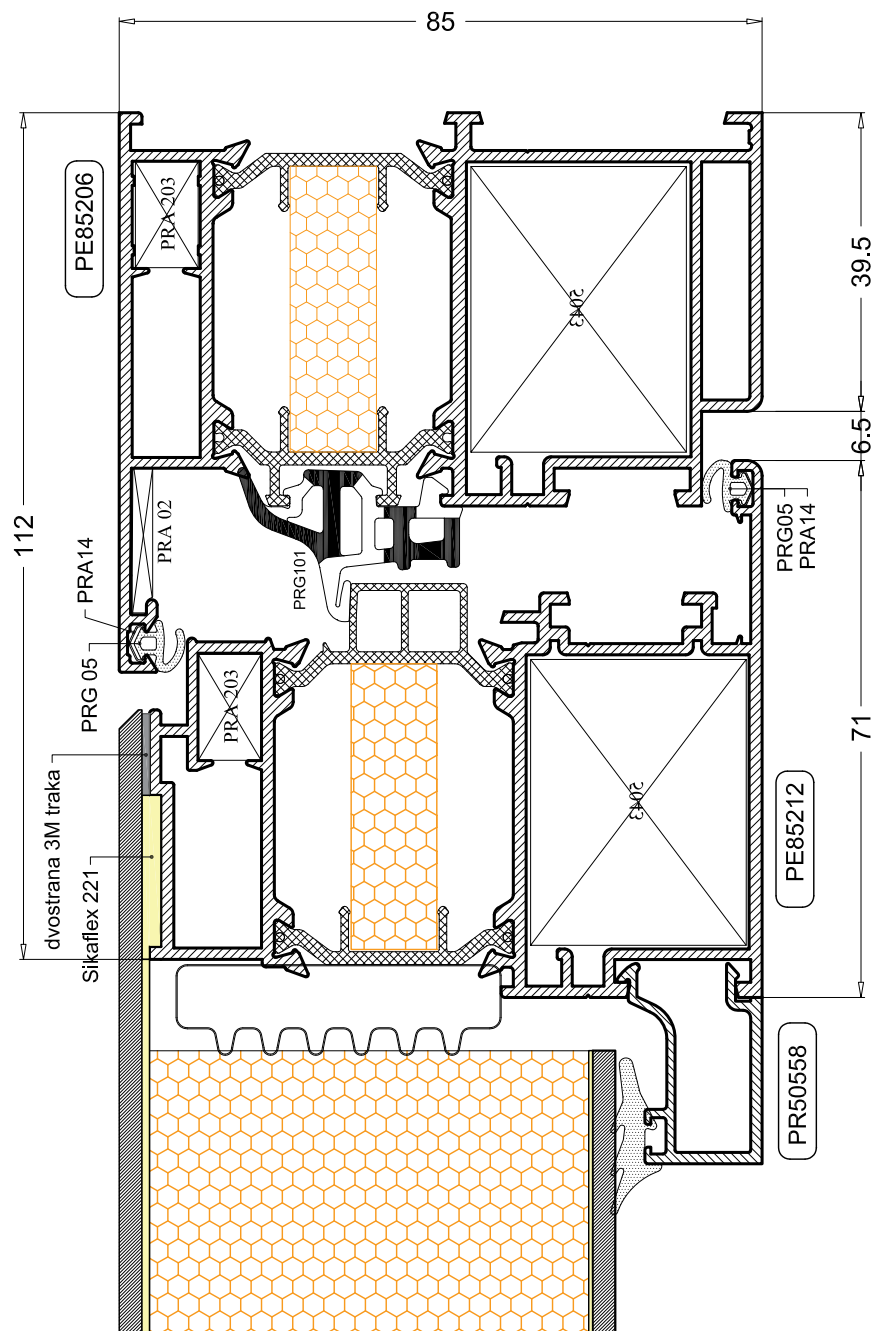
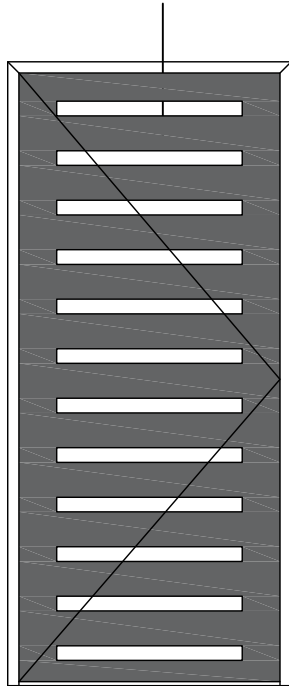

Jednokrilna panel vrata - Široki štok

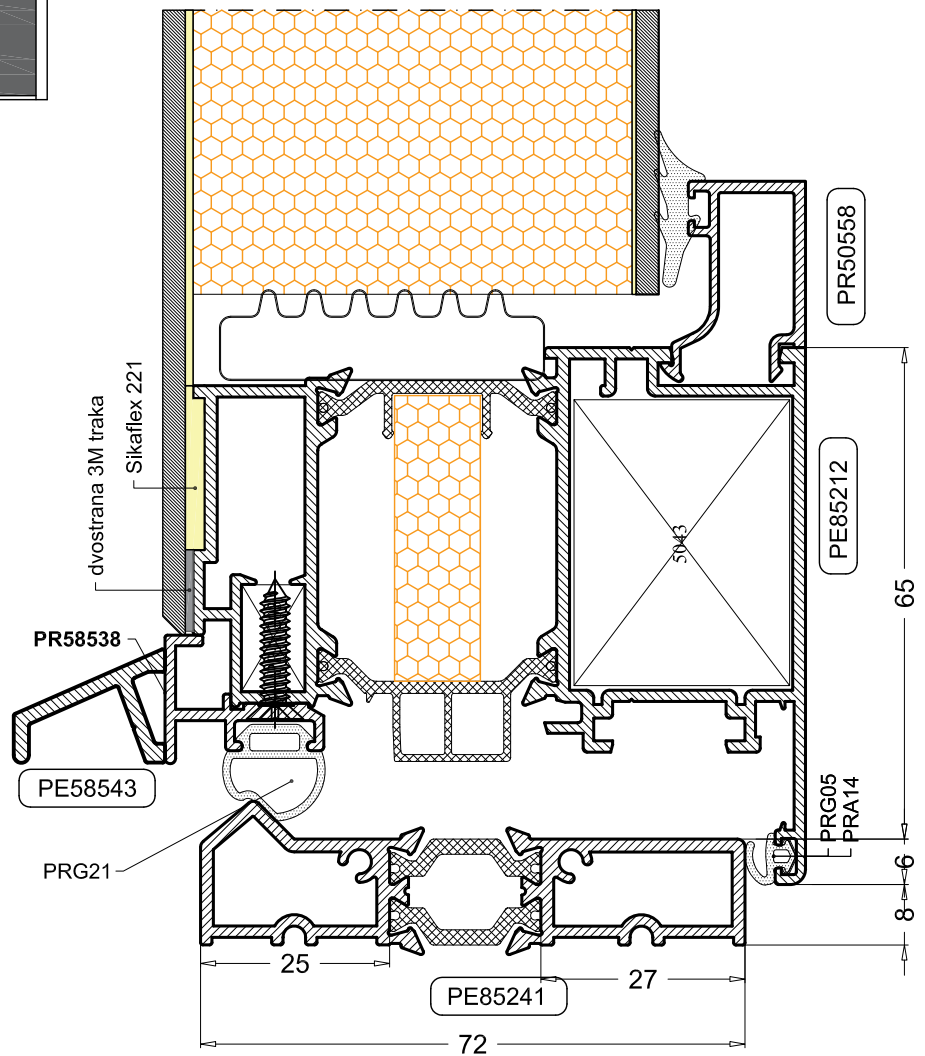
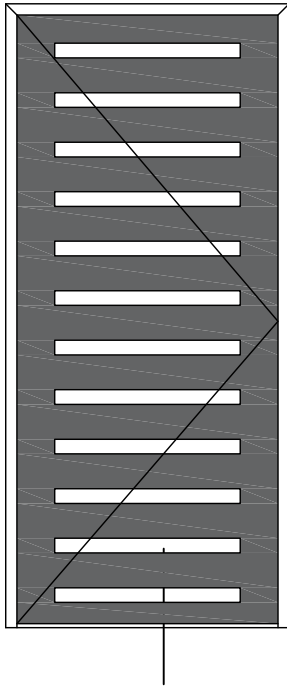

Jednokrilna panel vrata sa fiksnim dijelom - Široki štok

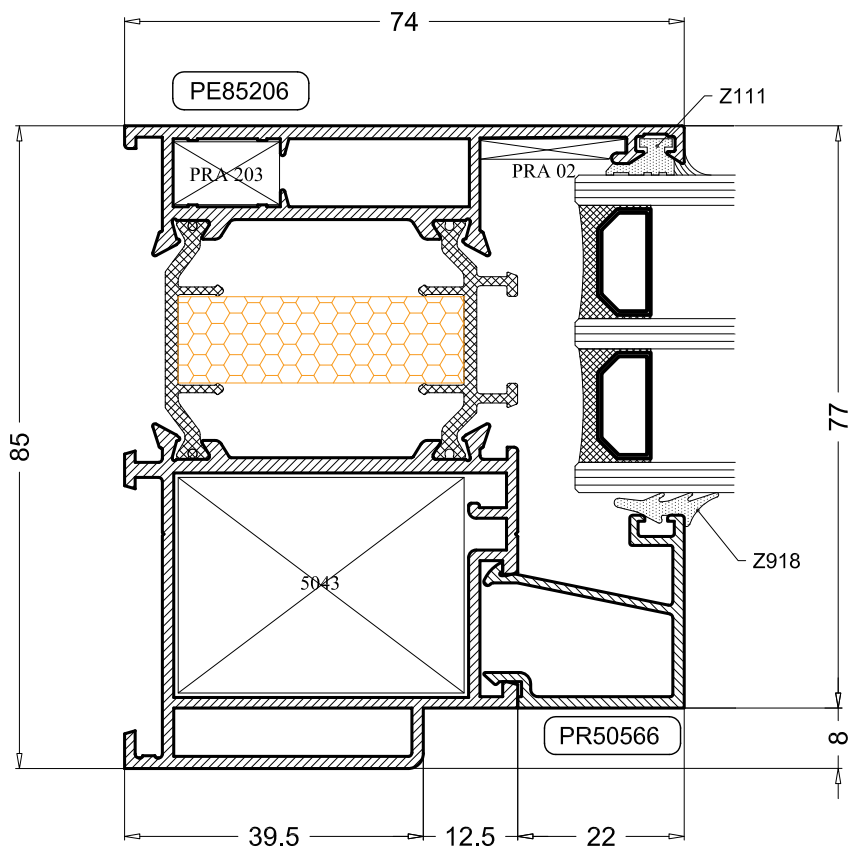
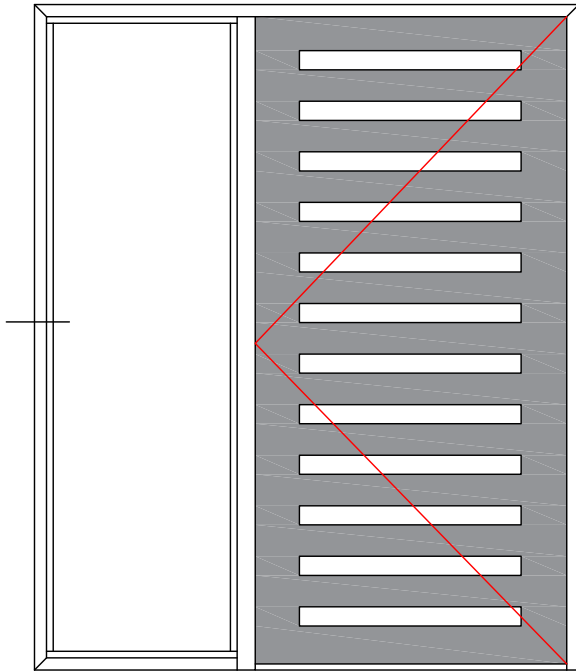

Jednokrilna panel vrata sa fiksnim dijelom - Široki štok

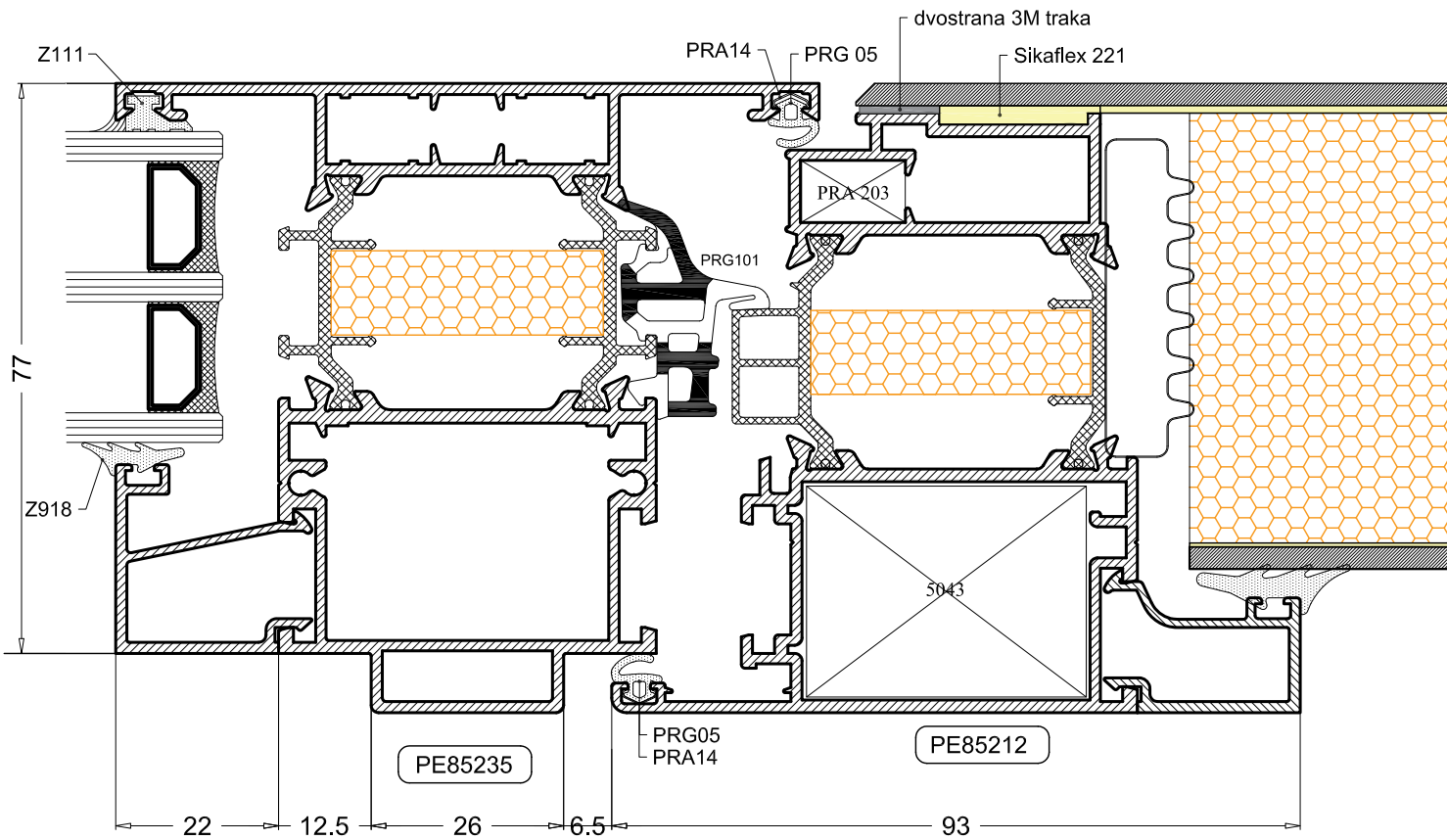
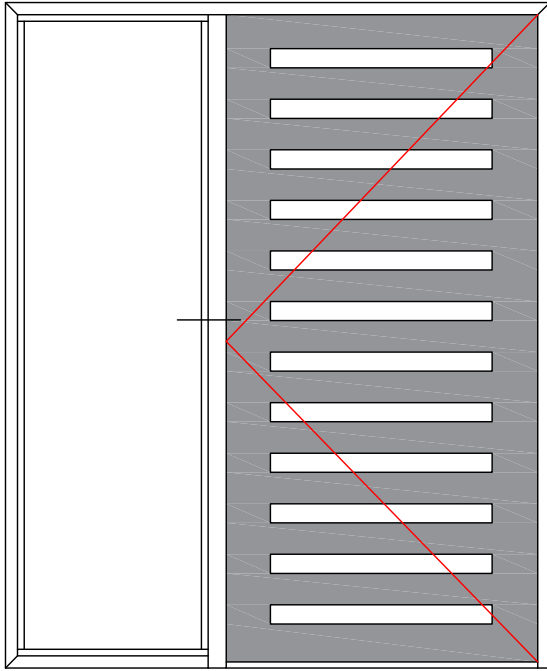



Jednokrilna vrata - Široki štok

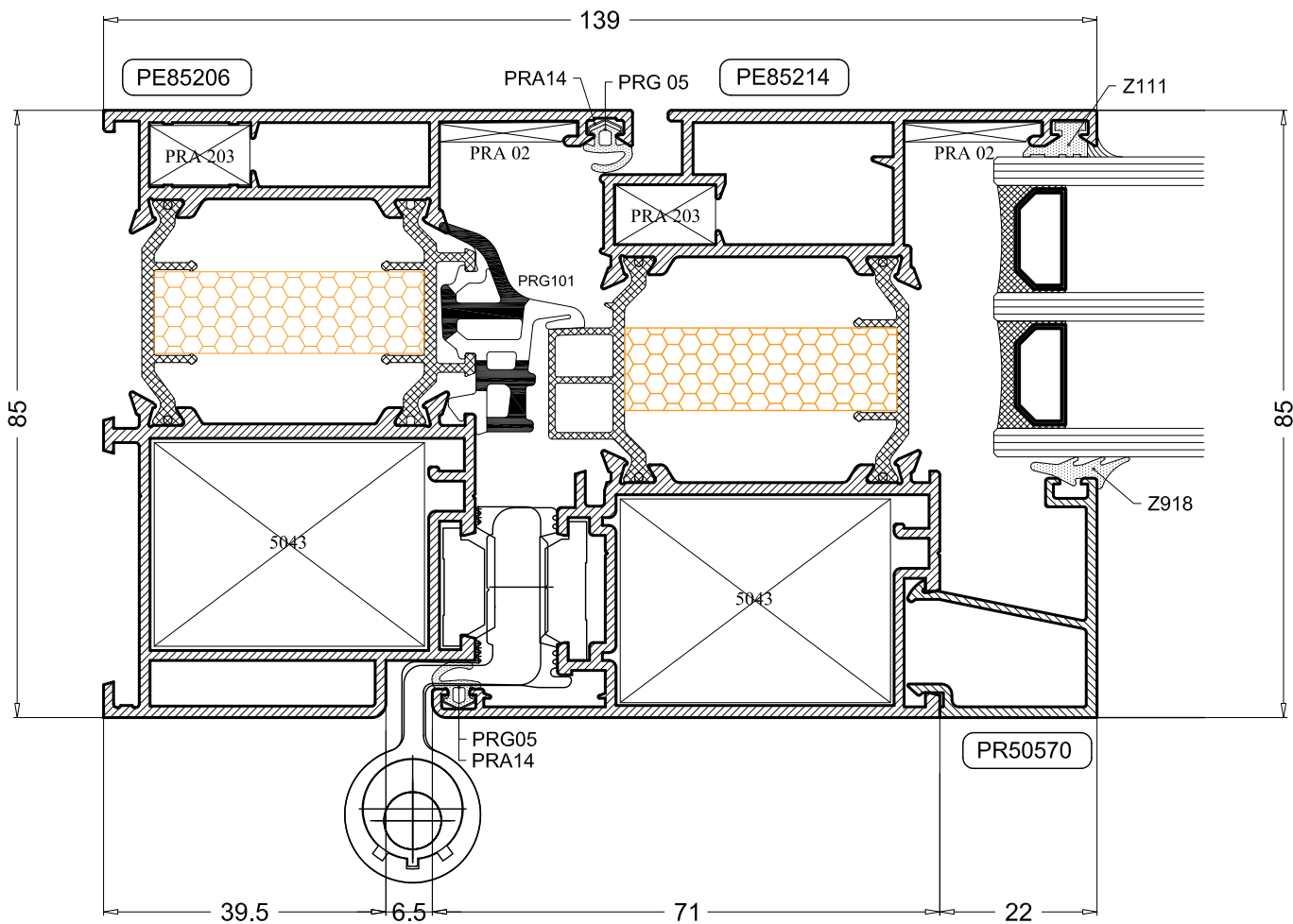
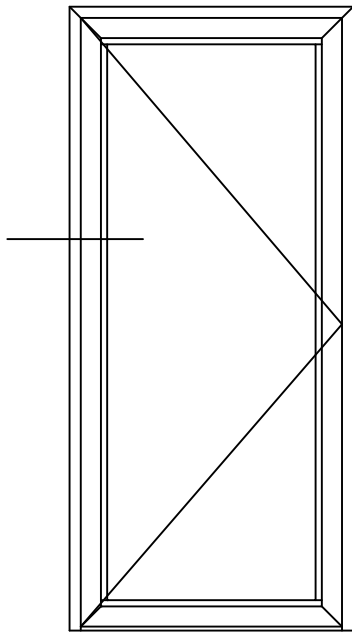

Jednokrilna vrata - Široki štok

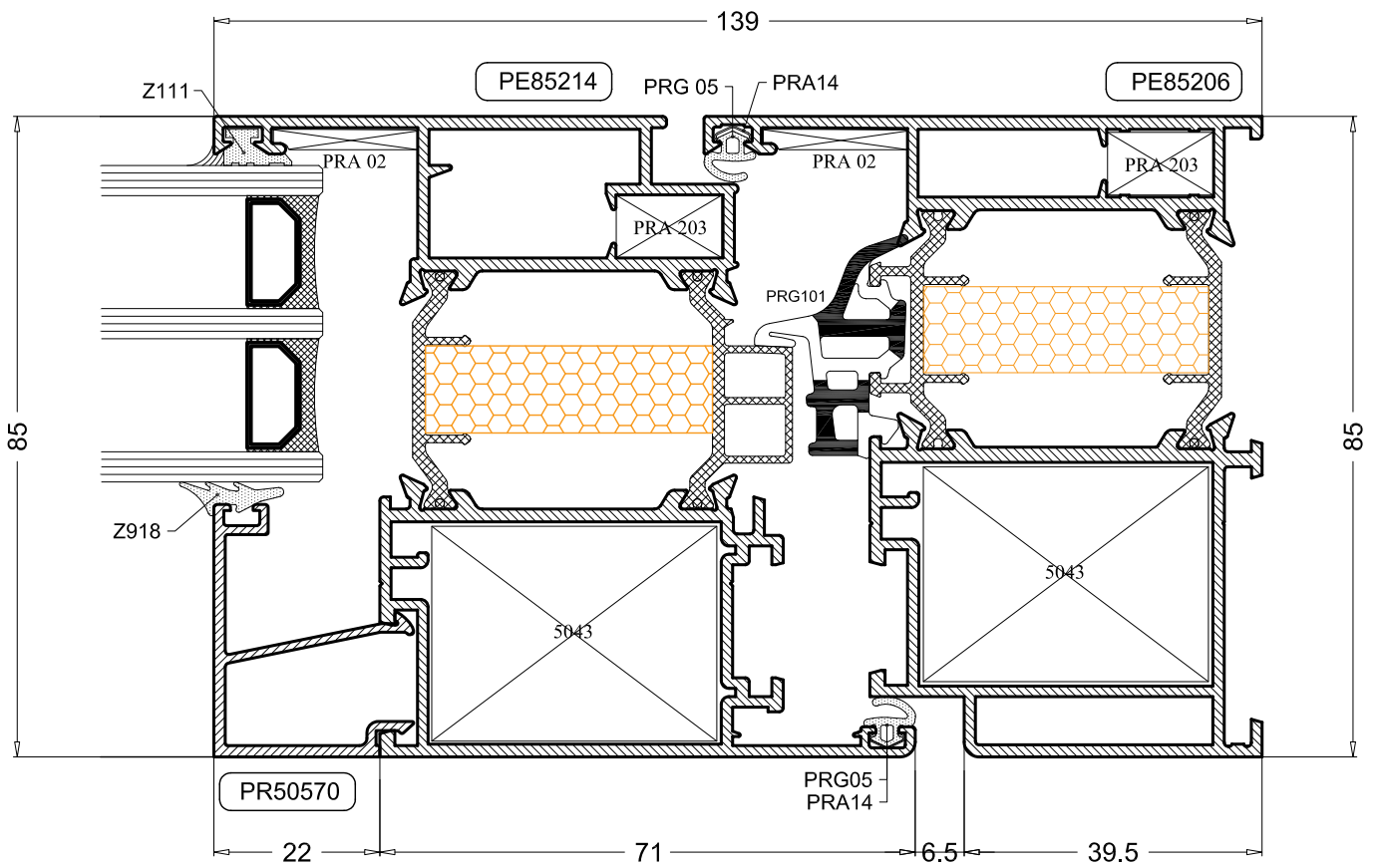
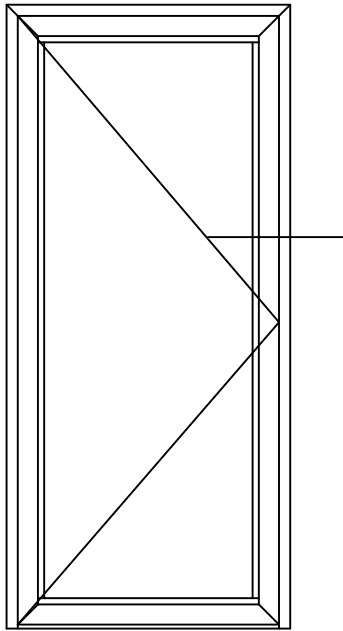

Jednokrilna vrata - Široki štok

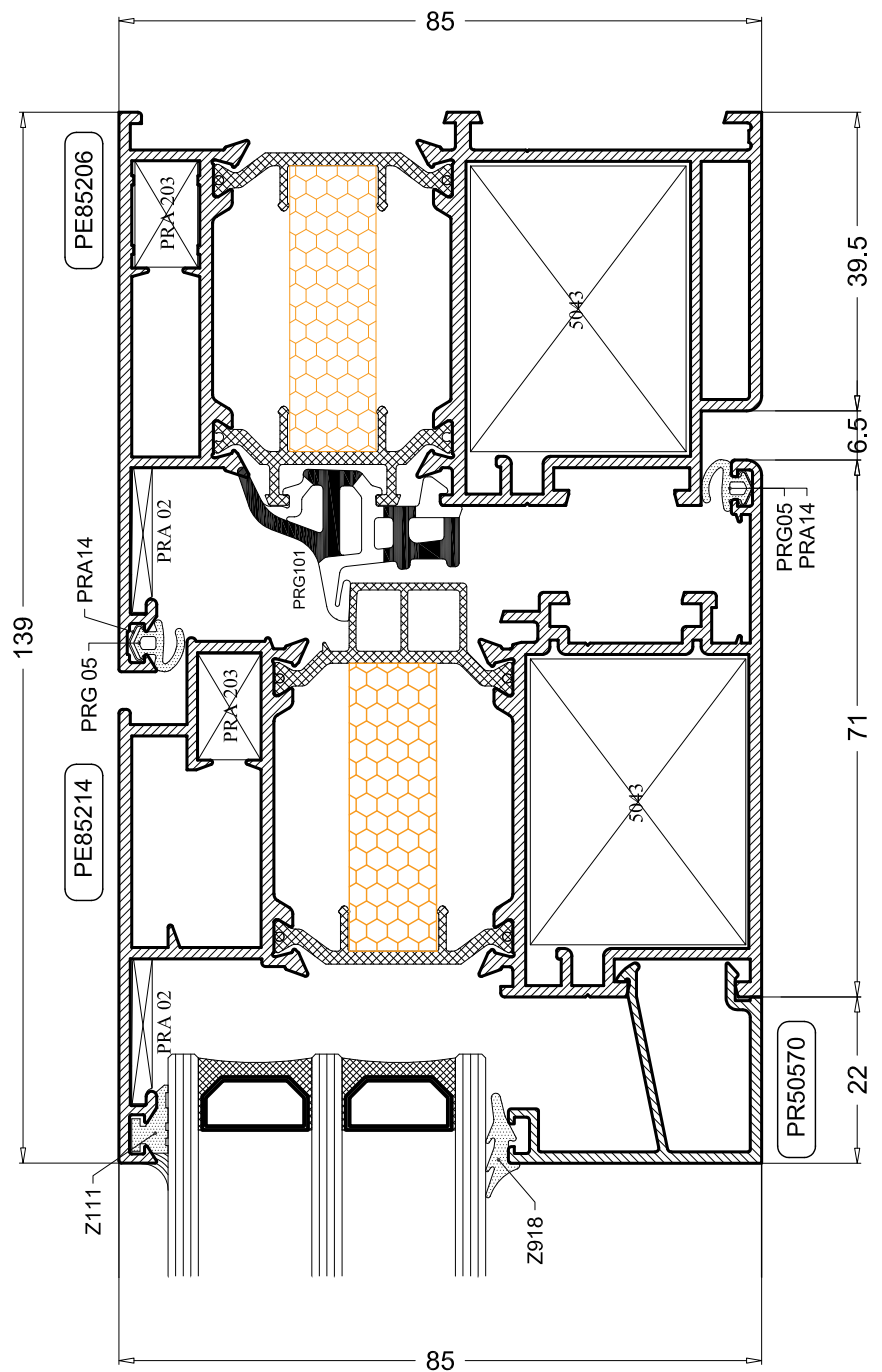
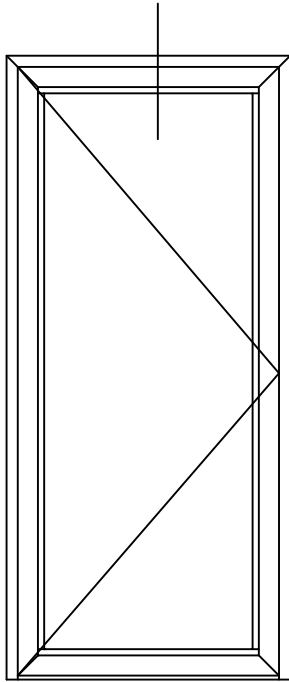

Jednokrilna vrata sa fiksnim dijelom - Široki štok

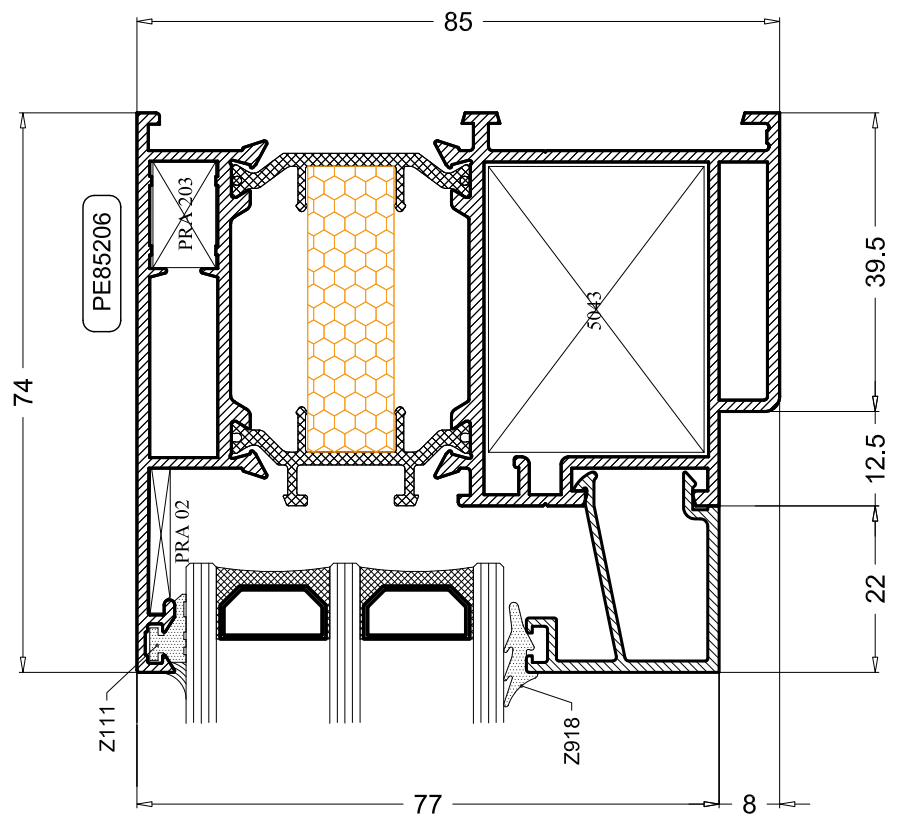
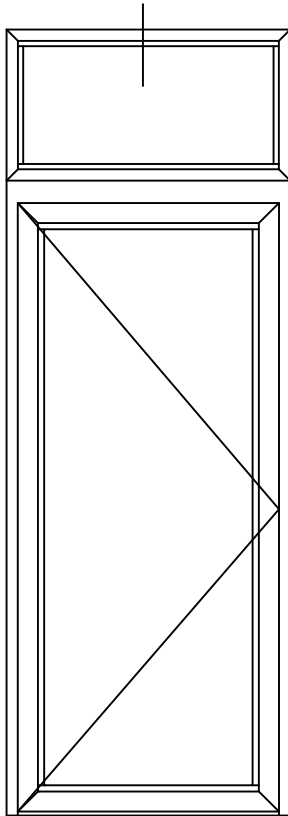

Jednokrilna vrata - Presjek sa pragom

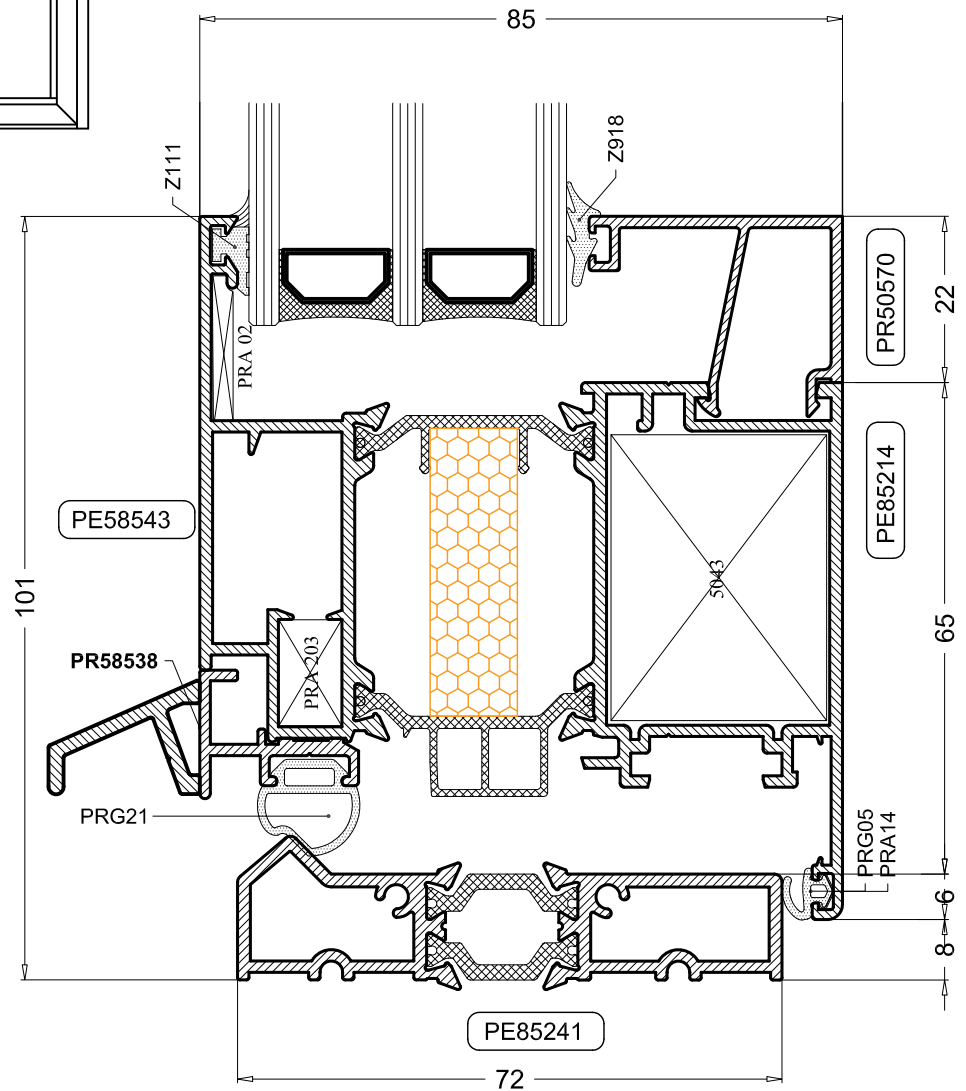
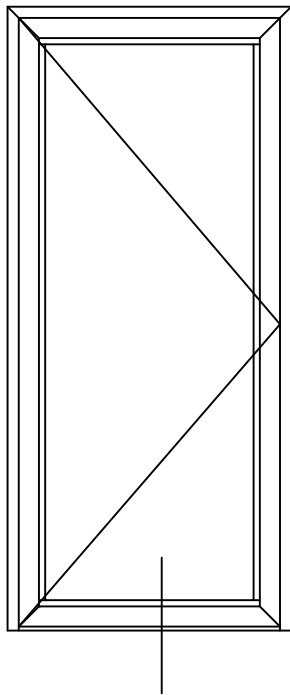

Jednokrilna vrata sa fiksnim dijelom - Široki štok

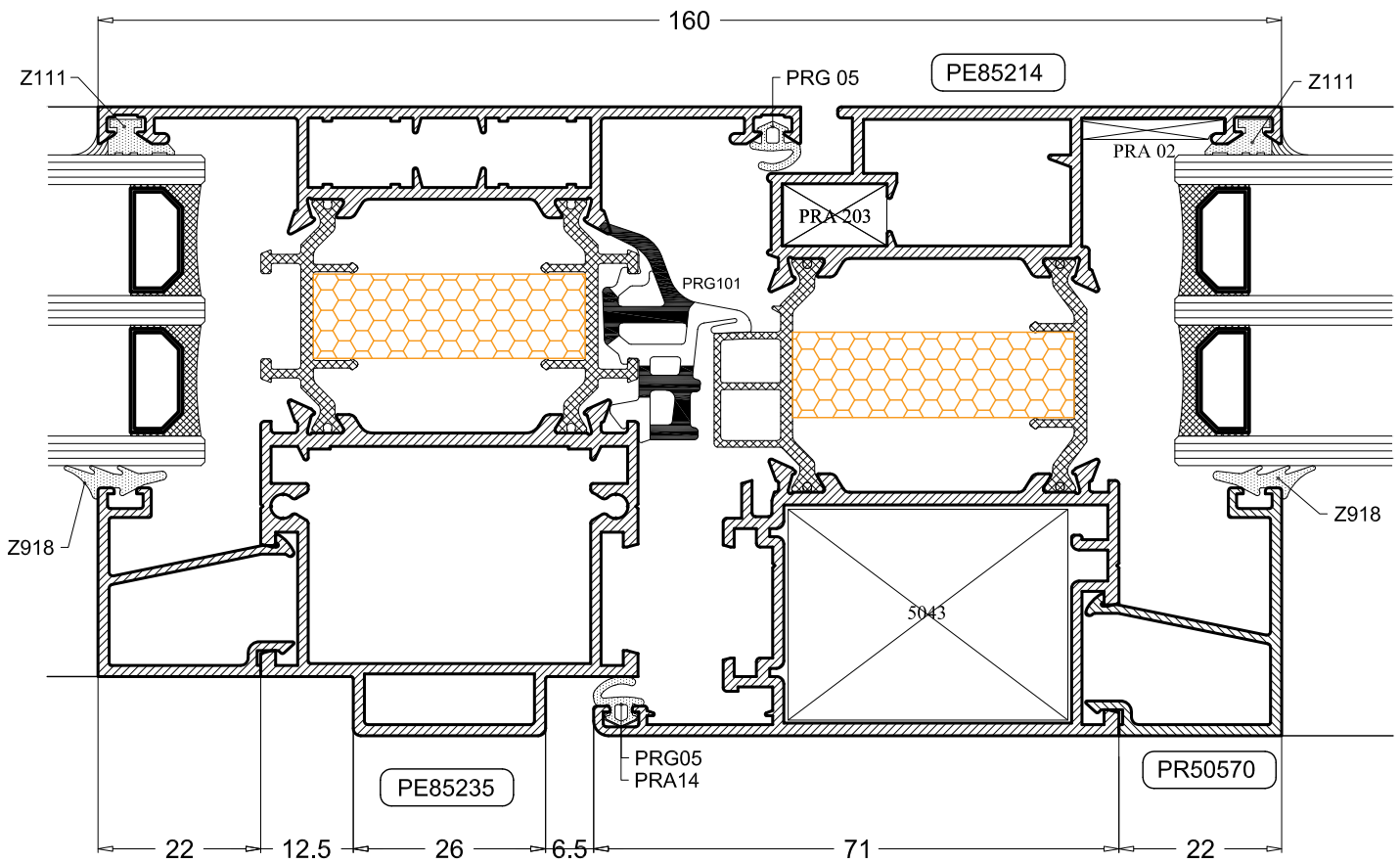
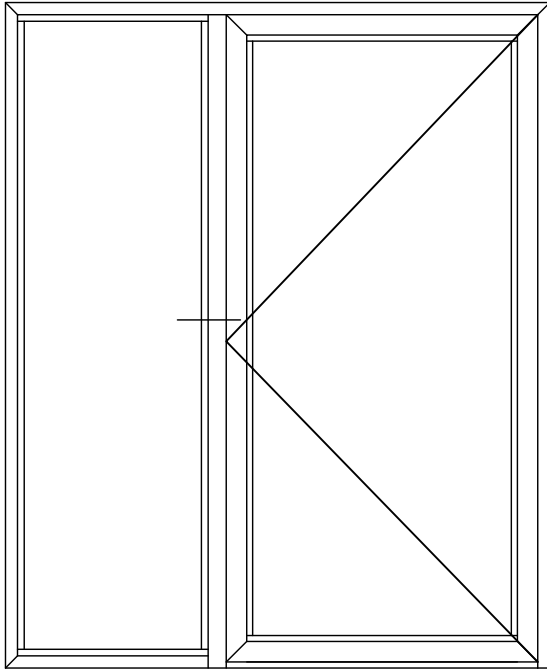

Jednokrilna vrata sa ventusom - Široki štok

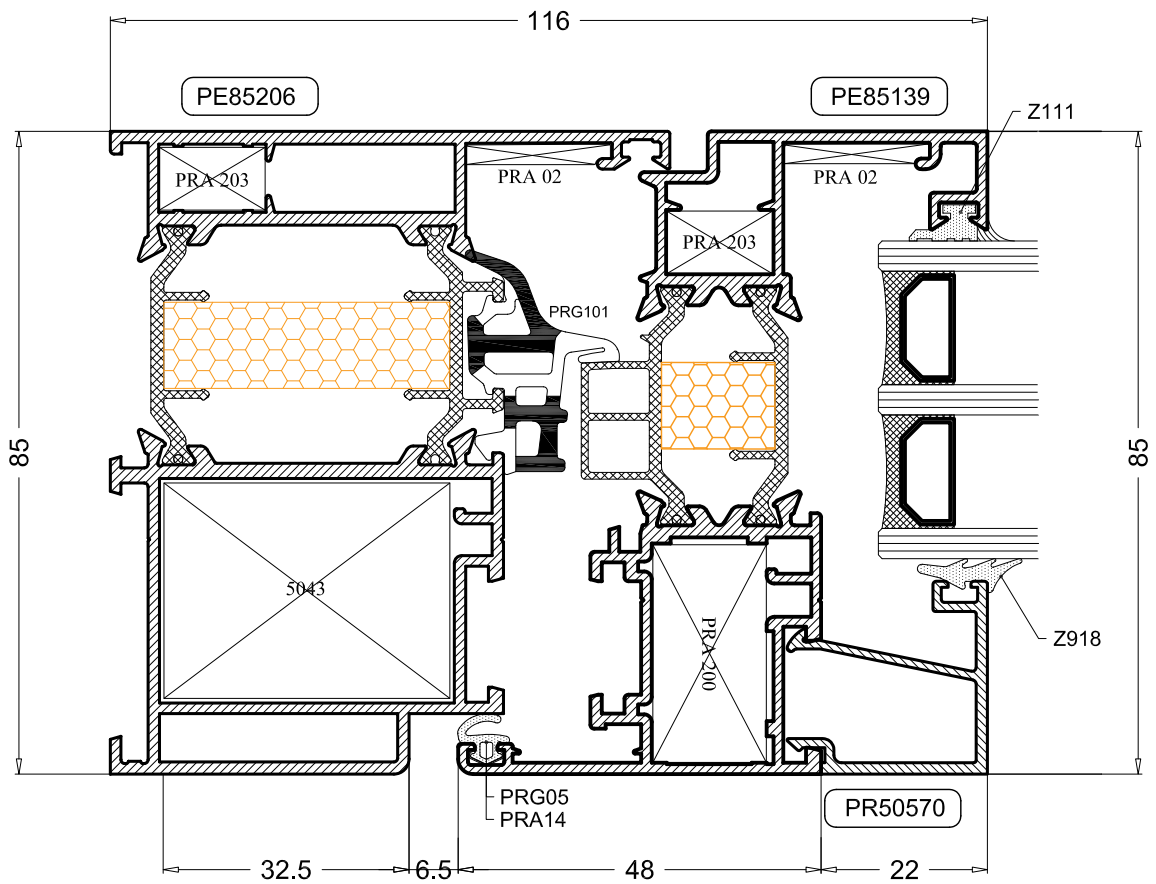
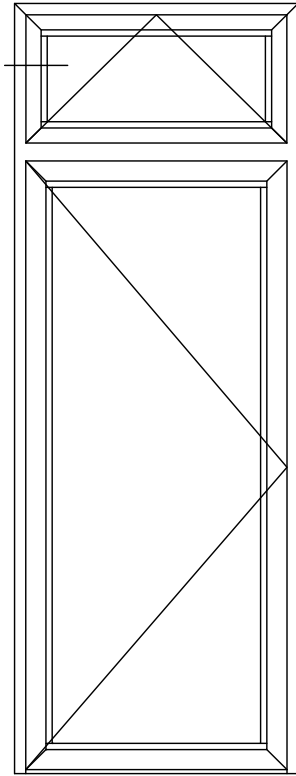

Jednokrilna vrata sa ventusom - Široki štok

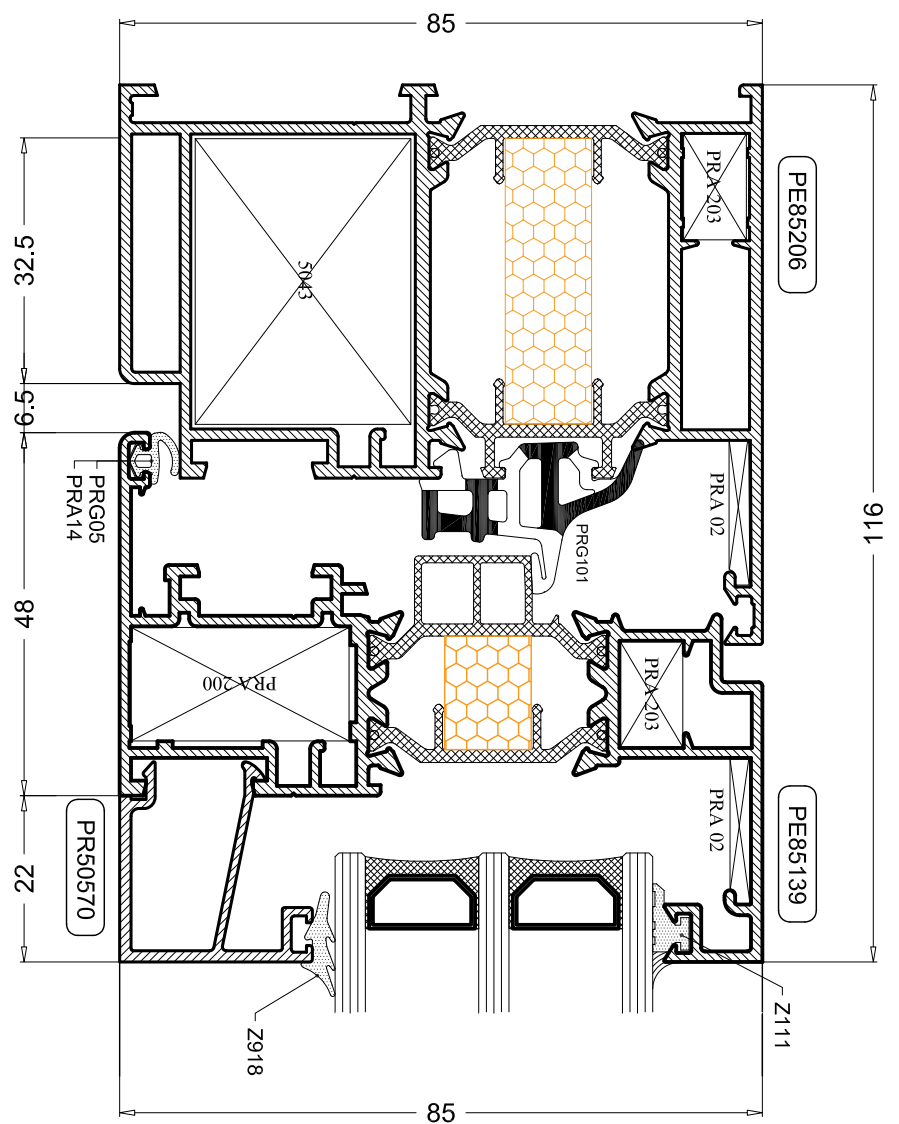
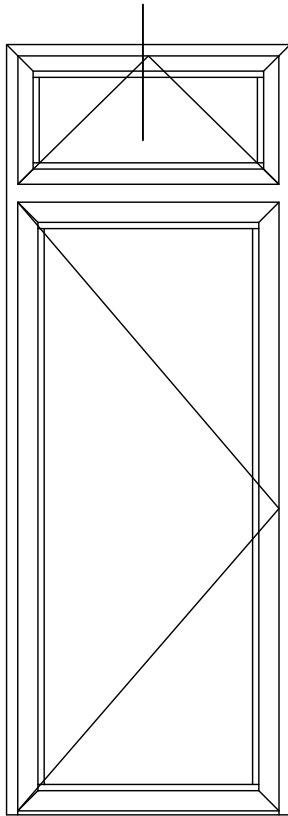



Jednokrilna vrata - Uski štok

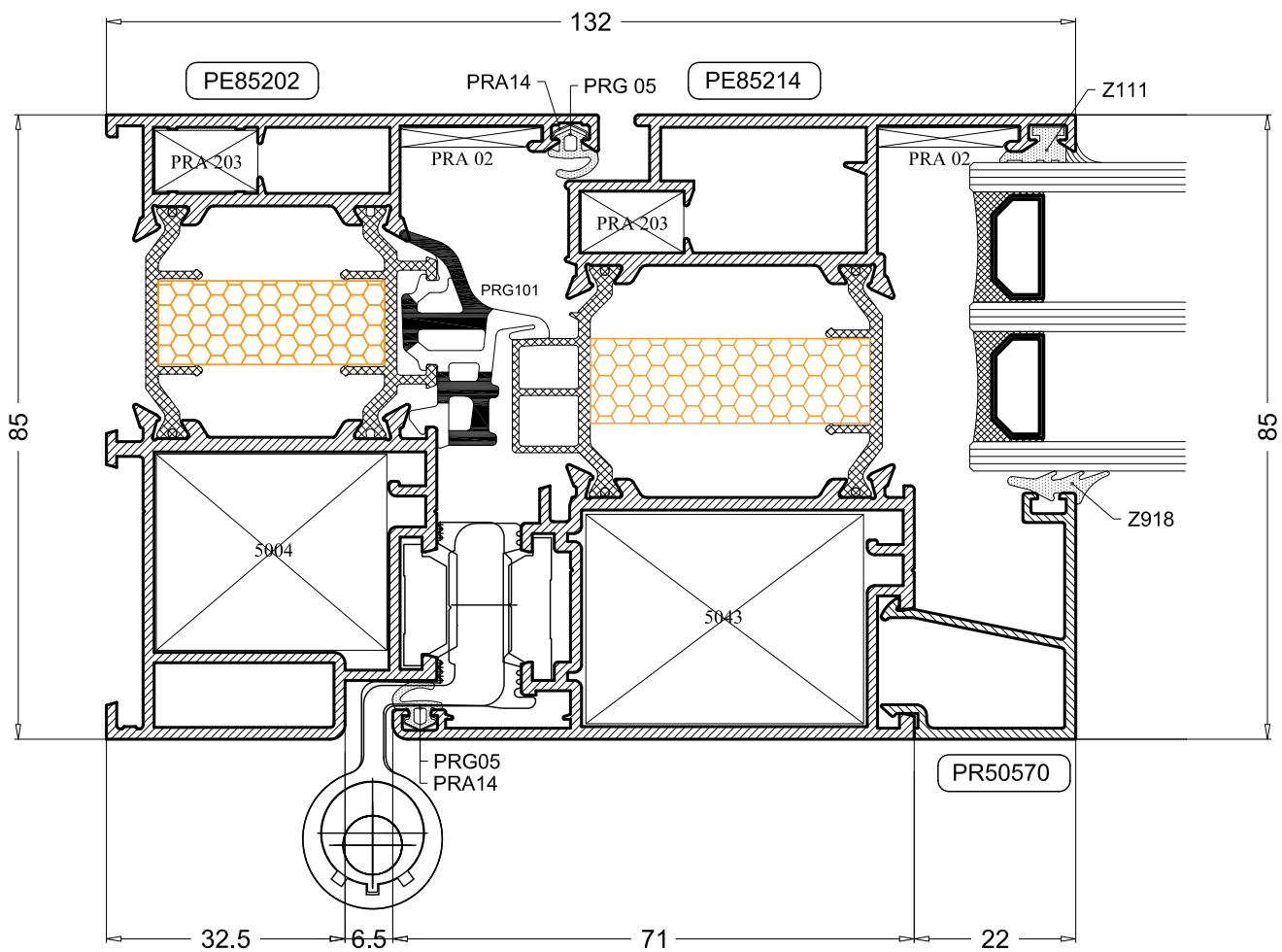
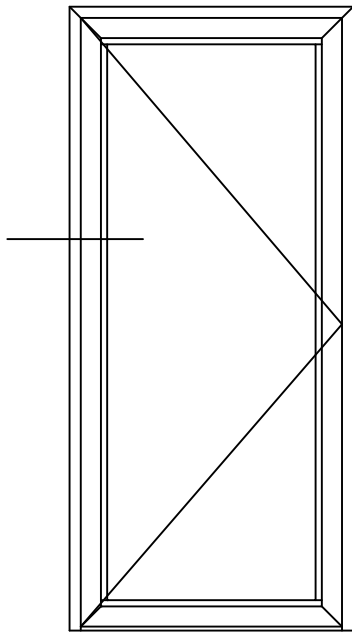

Jednokrilna vrata - Uski štok

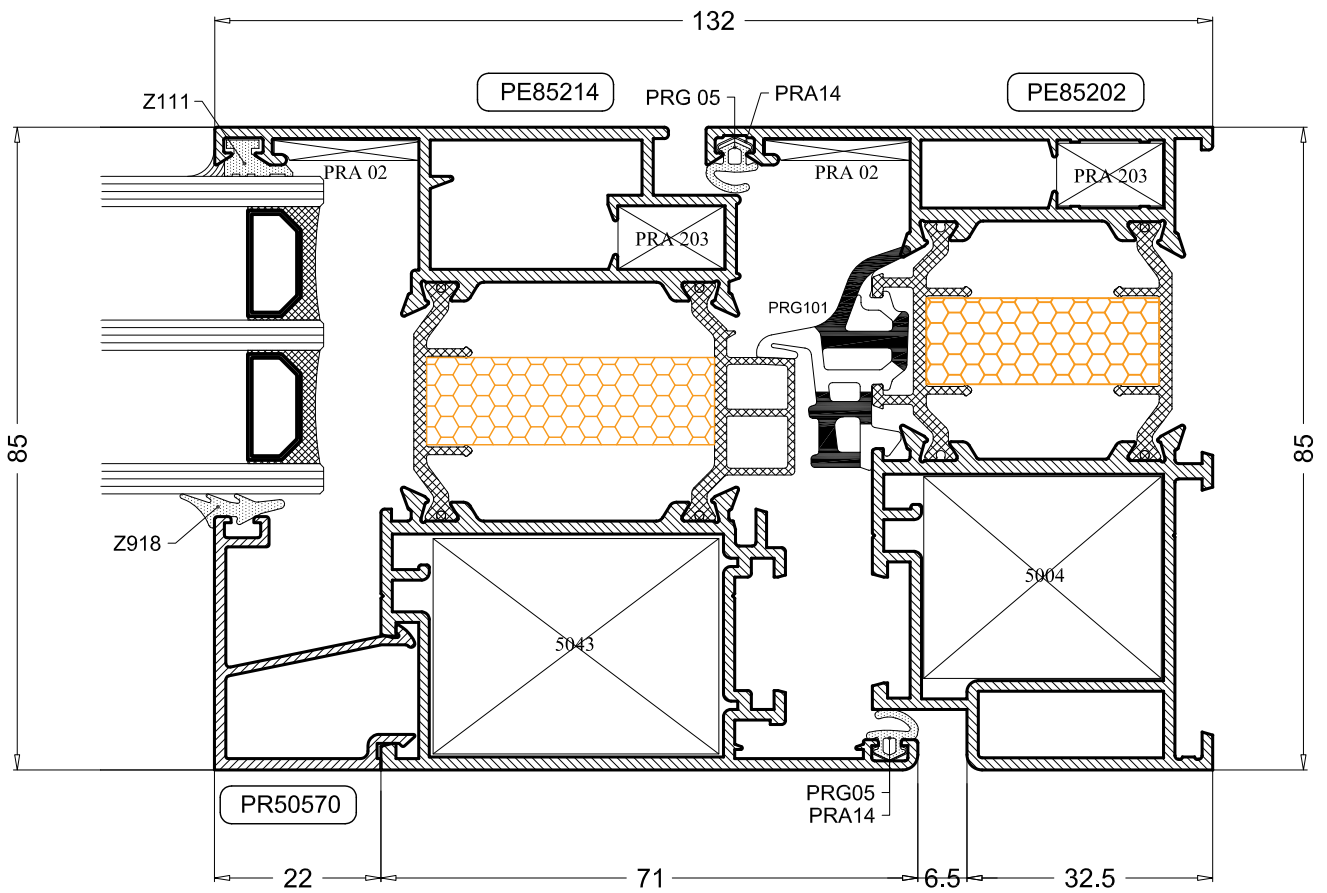
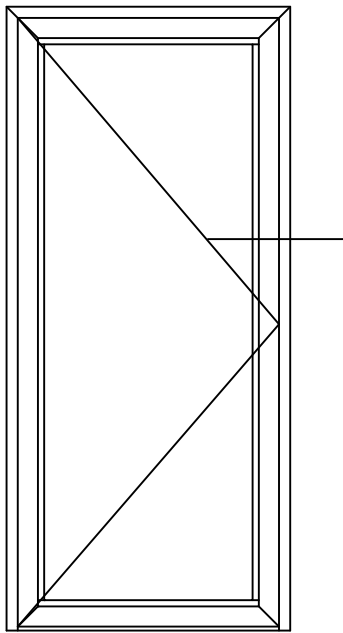

Jednokrilna vrata - Uski štok

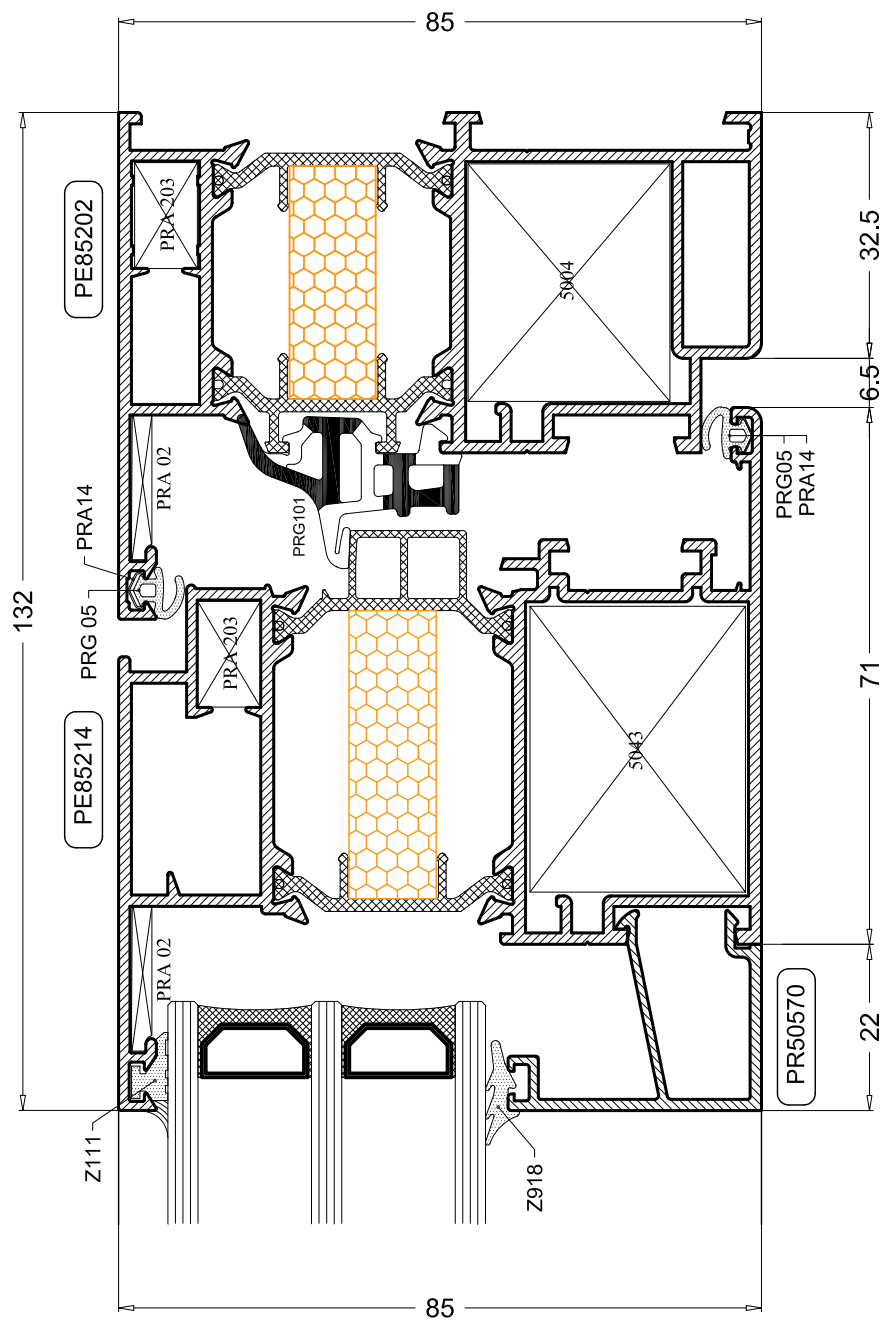
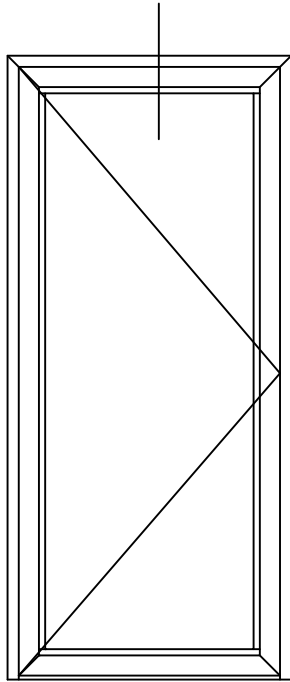

Jednokrilna vrata sa gornjim fiksnim dijelom

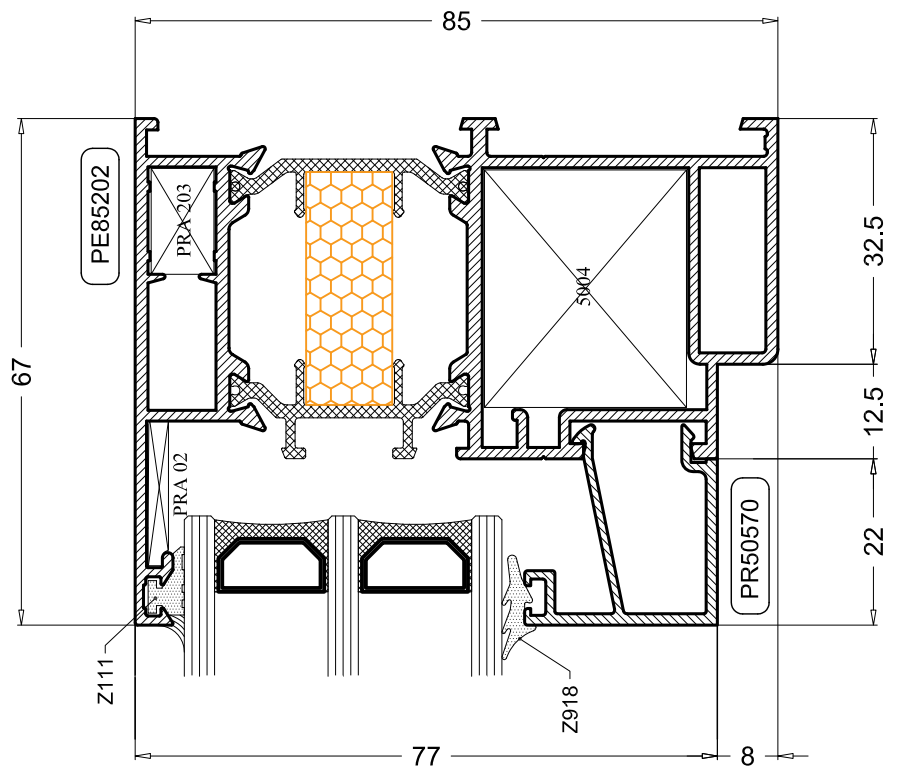
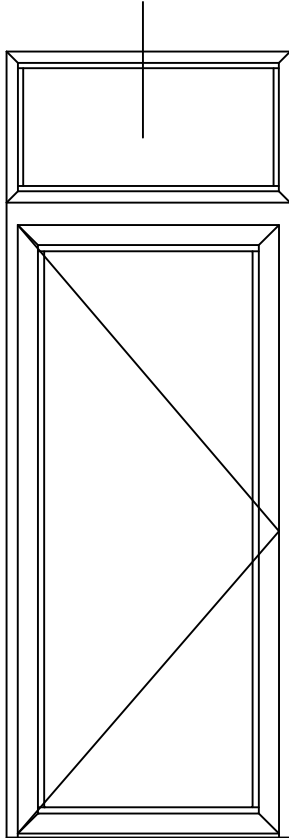

Jednokrilna vrata sa fiksnim dijelom - Uski štok

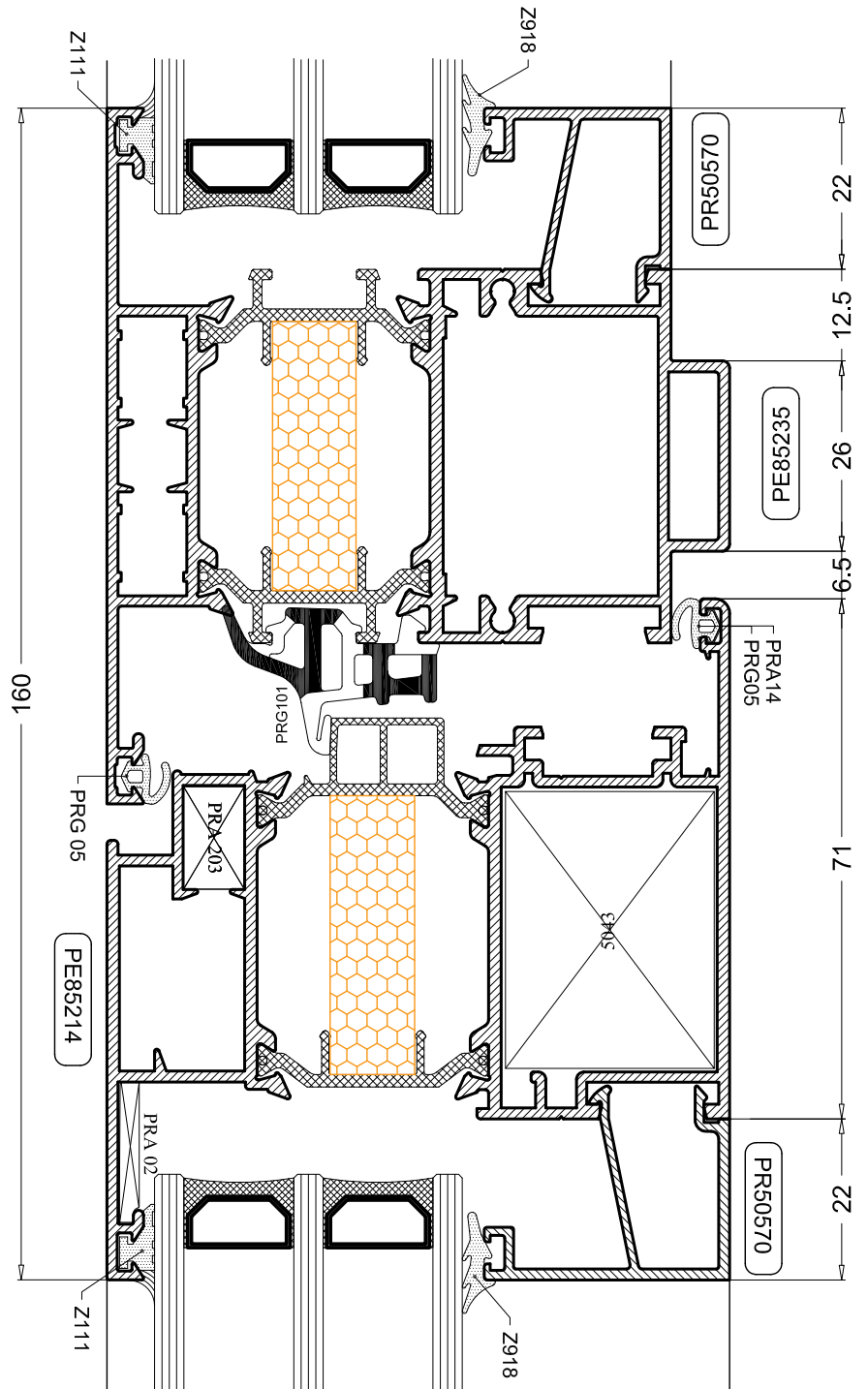
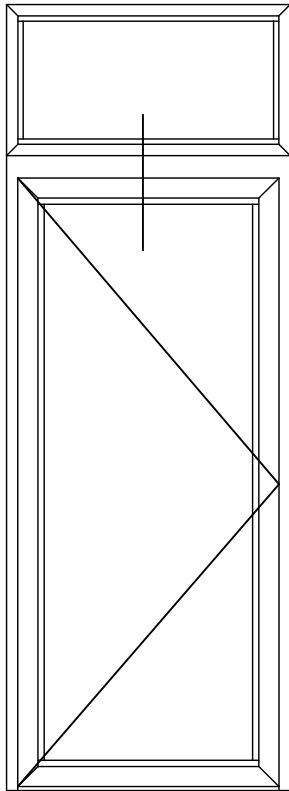

Jednokrilna vrata sa fiksnim dijelom - Unutarnje otvaranje - Uski štok

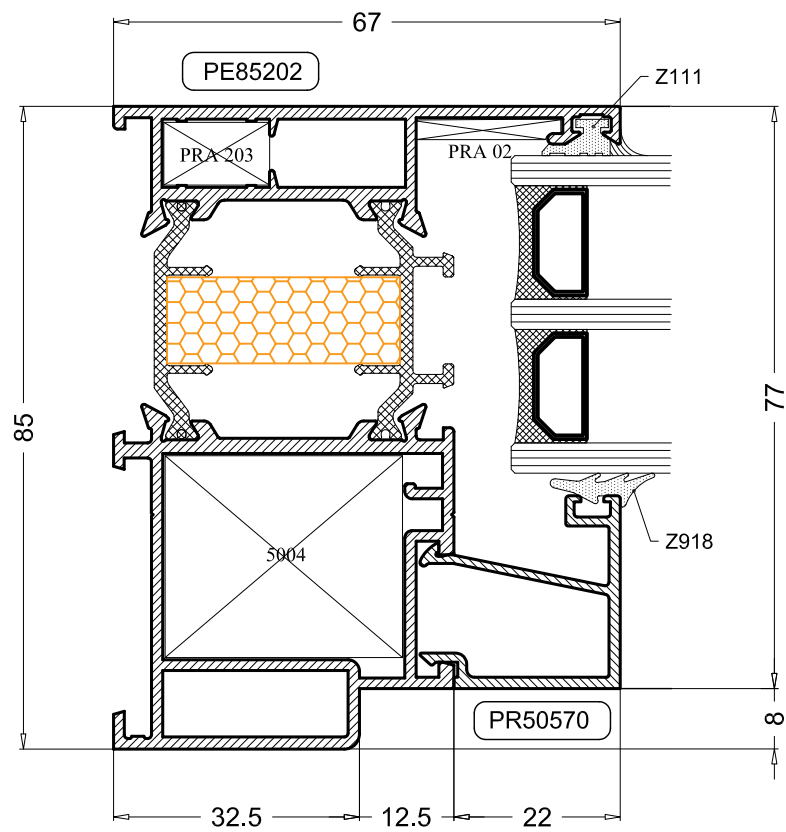
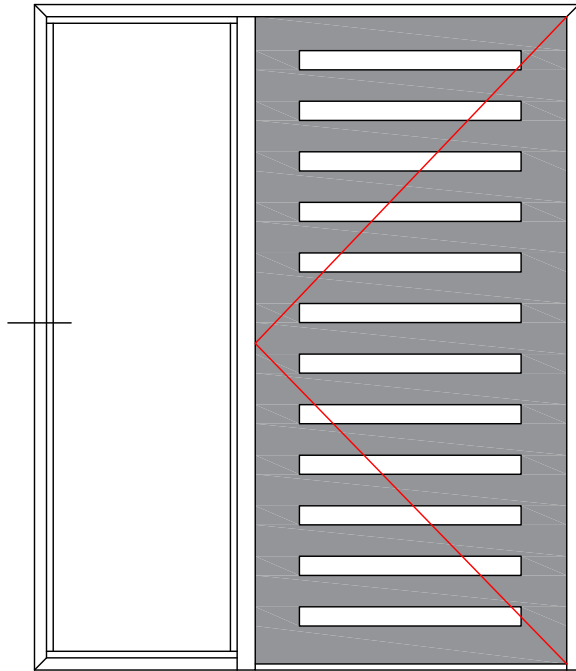

Jednokrilna vrata sa ventusom - Unutarne otvaranje - Uski štok

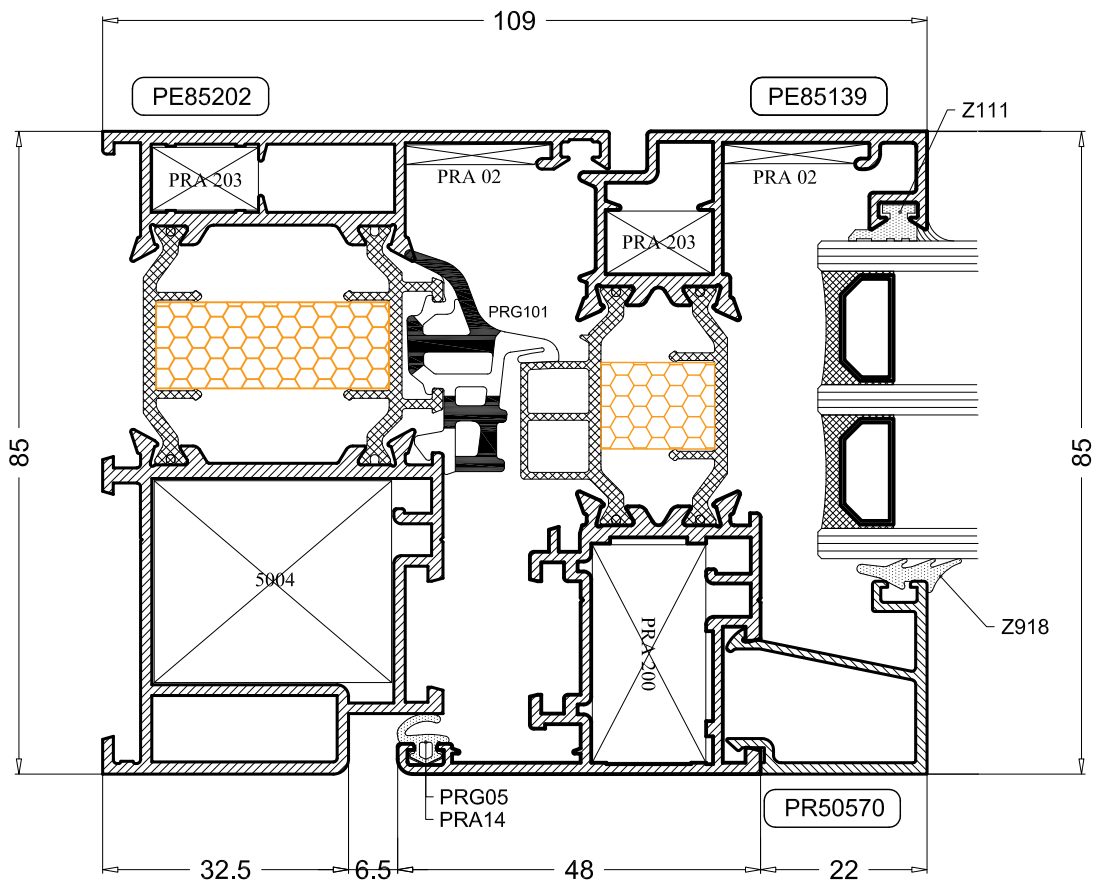
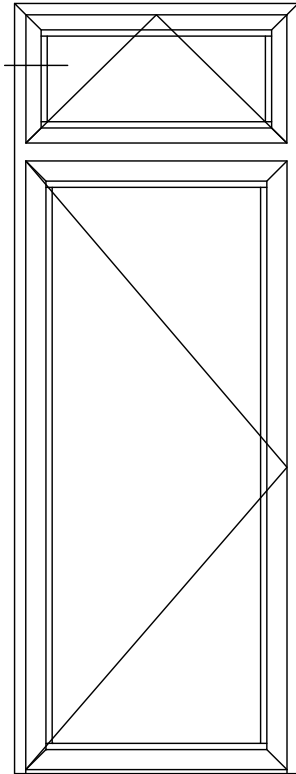

Jednokrilna vrata sa ventusom - Unutarne otvaranje - Uski štok

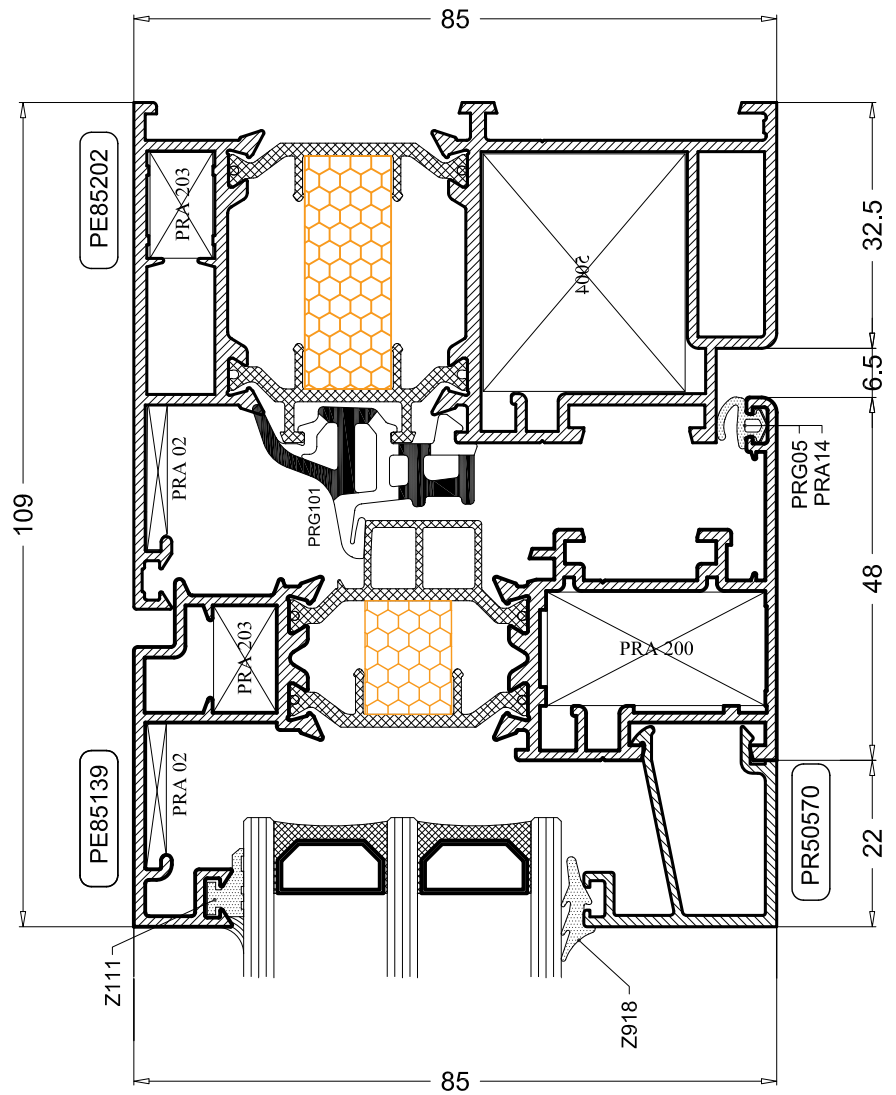
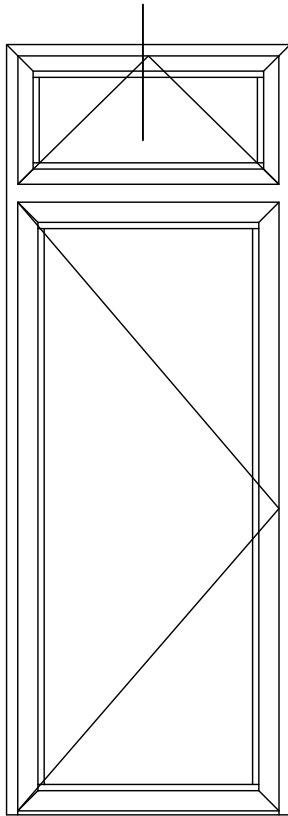





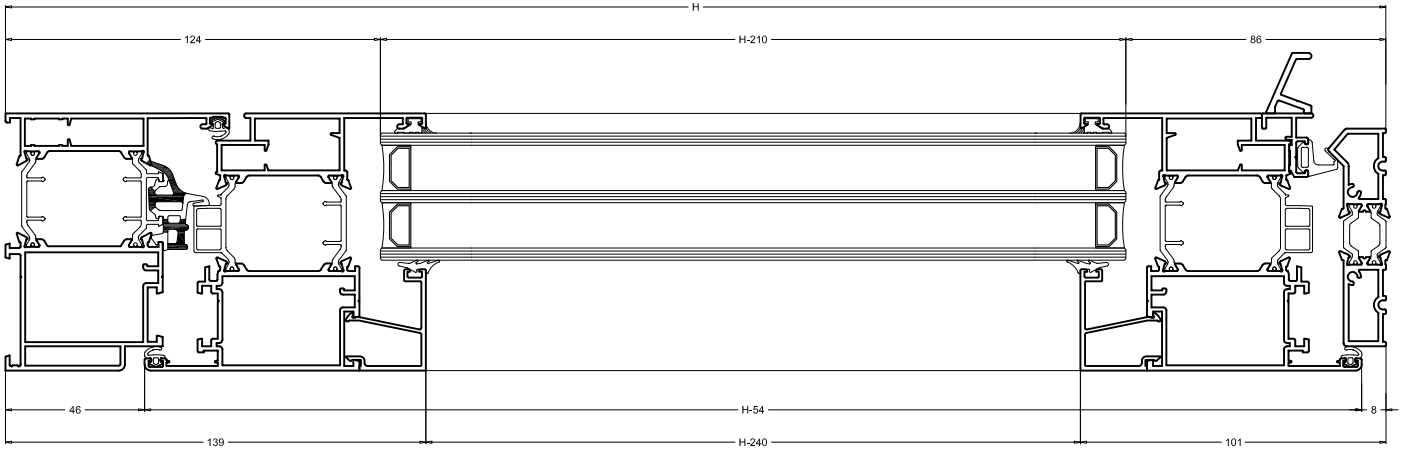

Rezne liste - Jednokrilna vrata - Veliki okvir

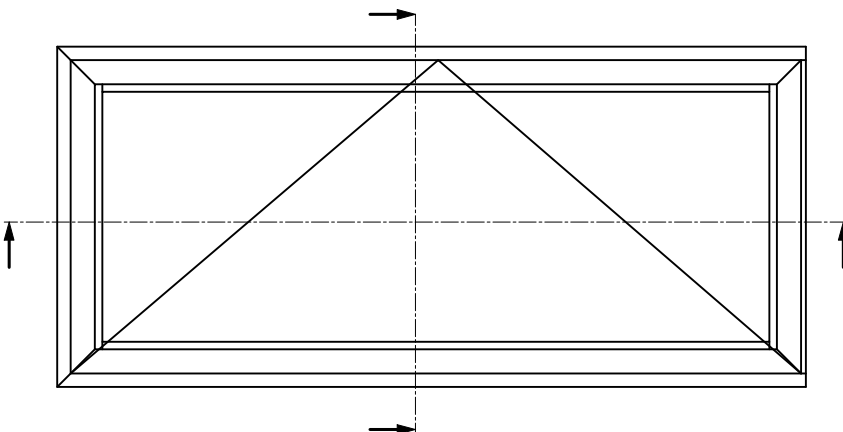
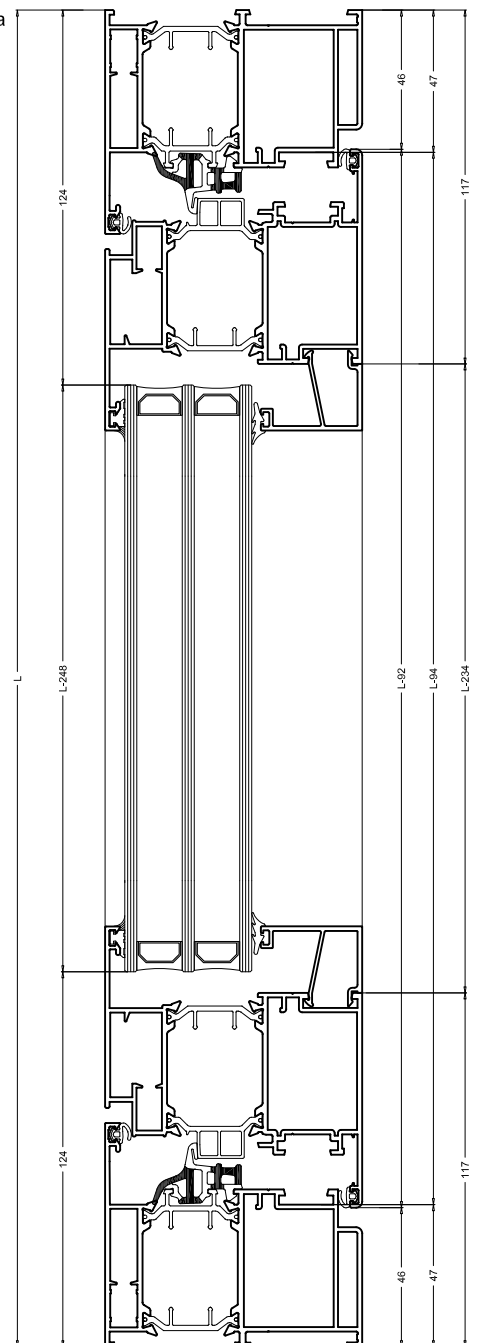

NAPOMENA: U slučaju korištenja čepova za prag dimenzija pilanja profila PE85241 će biti 20mm kraća od dimenzije navedene u tablici.

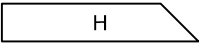

Rezne liste - Jednokrilna vrata - Veliki okvir

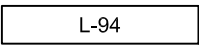
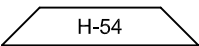
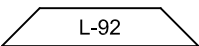
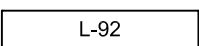
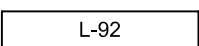
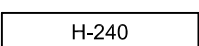
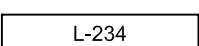
KOD	PROFIL	BR. KOM	REZANJE	KOD	OKOVI	BR. KOM	NOTE
PE 85206	OKOMICA OKVIRA	1L 1D		TONALE 5043	KUTNIK OKVIRA/KRILA	6	
PE 85206	GORNJA VODORAVNICA OKVIRA	1		PRA 02	KUTNIK PORAVNANJA OKVIRA/KRILA	6	
PE 85241	PRAG	1		PRA 203	KUTNIK PORAVNANJA KRILA/OKVIRA	6	
PE 85214	OKOMICA KRILA	1L 1D		PRA 14	KUTNIK PORAVNANJA KRILA/OKVIRA	6	
PE 85214	VODORAVNICA KRILA	2					
PR 58538	NOSAČ BRTVE	1					
PR 58543	OKAPNICA	1					
-	OKOMITA LAJSNA	2					
-	VODORAVNA LAJSNA	2					

NAPOMENA: U slučaju korištenja čepova za prag dimenzija pilanja profila PE85241 će biti 20mm kraća od dimenzije navedene u tablici.

KOD	BRTVE/ČEPOVI	BR. KOM	NOTE
PRG 101	CENTRALNA BRTVA	3	1L + 2H
PRA 91	KUTNIK CENTRALNE BRTVE	2	-
PRG 05	UNUTARNJA BRTVA KRILA	7	3L + 4H
PRG 21	BRTVA PRAGA	1	L
PRG -	VANJSKA BRTVA STAKLA	2	2L + 2H
PRG -	UNUTARNJA BRTVA STAKLA	2	2L + 2H

GORNJA STAKLA		DONJA STAKLA	
(L-248) x (H-210)	1		

Rezne liste - Jednokrilna vrata s panelom - Veliki okvir

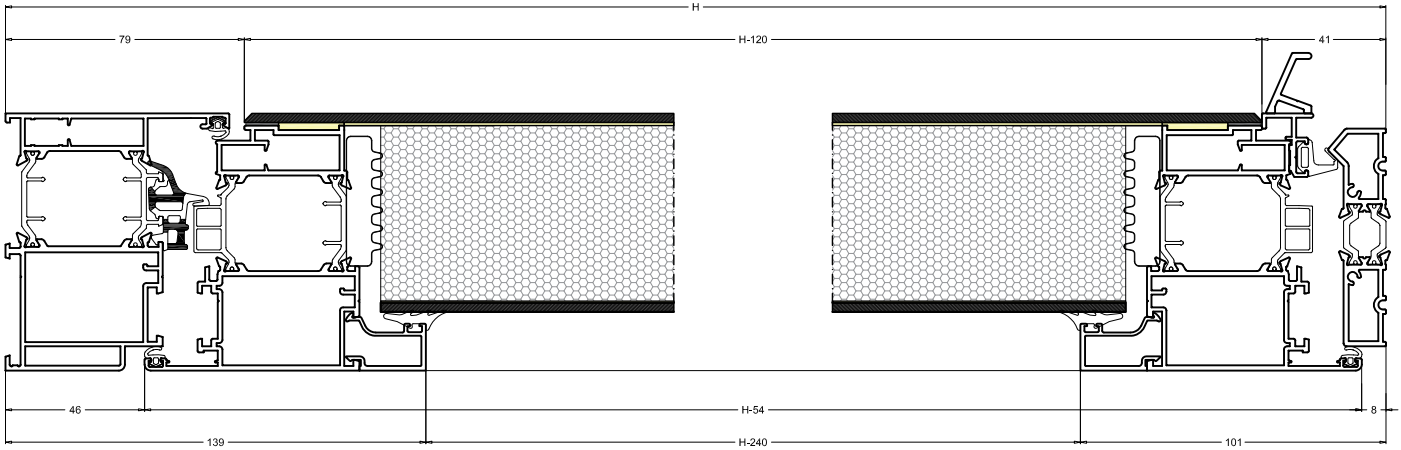

NAPOMENA: U slučaju korištenja čepova za prag dimenzija pilanja profila PE85241 će biti 20mm kraća od dimenzije navedene u tablici.

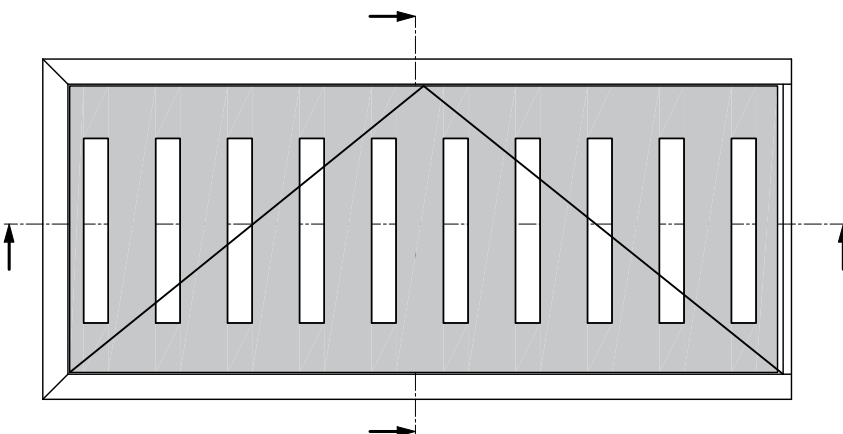
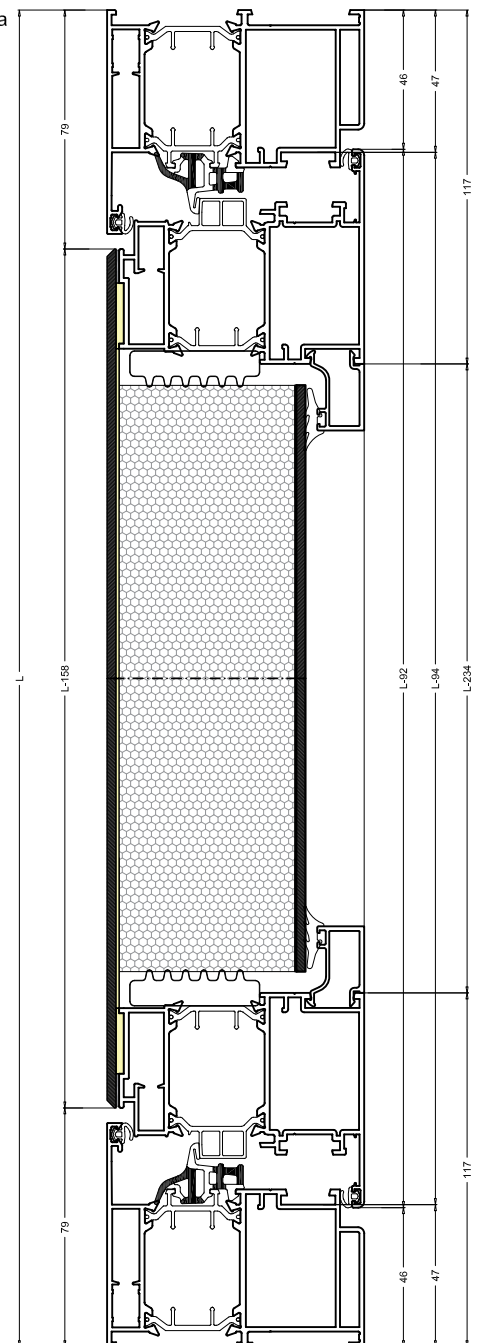

## Rezne liste - Jednokrilna vrata - Veliki okvir

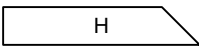
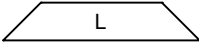
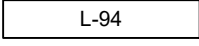
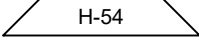
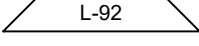
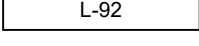
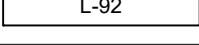
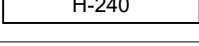
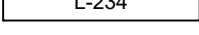
KOD	PROFIL	BR. KOM	REZANJE	KOD	OKOVI	BR. KOM	NOTE
PE 85206	OKOMICA OKVIRA	1L 1D		TONALE 5043	KUTNIK OKVIRA/KRILA	6	
PE 85206	GORNJA VODORAVNICA OKVIRA	1		PRA 02	KUTNIK PORAVNANJA OKVIRA/KRILA	2	
PE 85241	PRAG	1		PRA 203	KUTNIK PORAVNANJA KRILA/OKVIRA	6	
PE 85212	OKOMICA KRILA	1L 1D		PRA 14	KUTNIK PORAVNANJA KRILA/OKVIRA	6	
PE 85212	VODORAVNICA KRILA	2					
PR 58538	NOSAČ BRTVE						
PR 58543	OKAPNICA	1					
-	OKOMITA LAJSNA	2					
-	VODORAVNA LAJSNA	2					

NAPOMENA: U slučaju korištenja čepova za prag dimenzija pilanja profila PE85241 će biti 20mm kraća od dimenzije navedene u tablici.

KOD	BRTVE/ČEPOVI	BR. KOM	NOTE		
PRG 101	CENTRALNA BRTVA	3	1L + 2H		
PRA 91	KUTNIK CENTRALNE BRTVE	2	-		
PRG 05	UNUTARNJA BRTVA KRILA	7	3L + 4H		
PRG 21	BRTVA PRAGA	1	L		
PRG -	VANJSKA BRTVA STAKLA	2	2L + 2H		
PRG -	UNUTARNJA BRTVA STAKLA	2	2L + 2H		

  

VANJSKI PANEL		UNUTARNJI PANEL	
(L-158) x (H-120)	1	(L-248) x (H-210)	1

Obrada na profilu PE85110 i PE85139 za montiranje kutnika 5011 i PRA 203

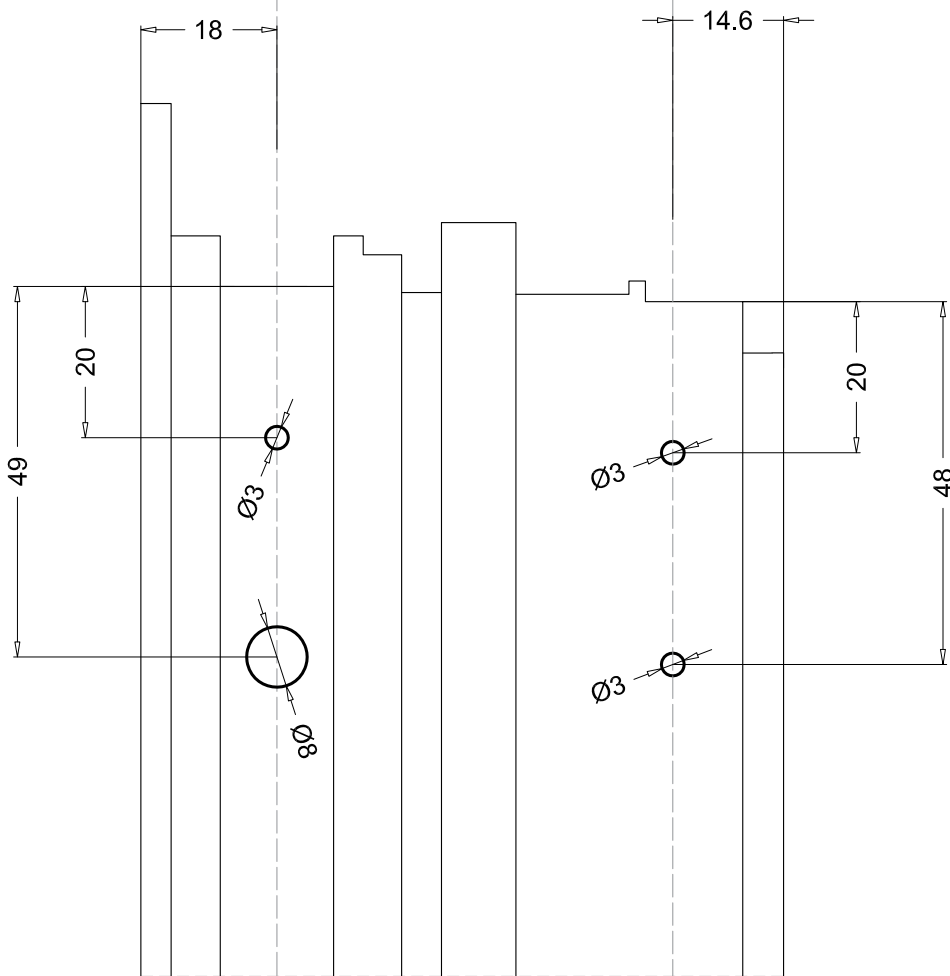
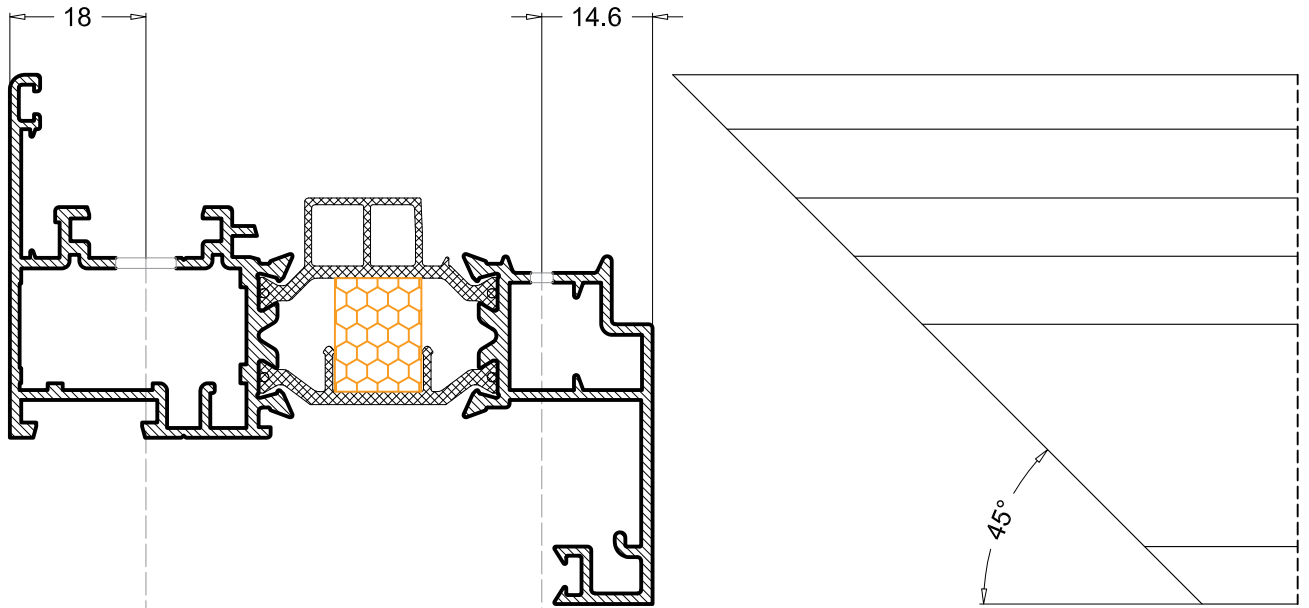

Obrada na profilu PE85202 za montiranje kutnika 5004 i PRA 203

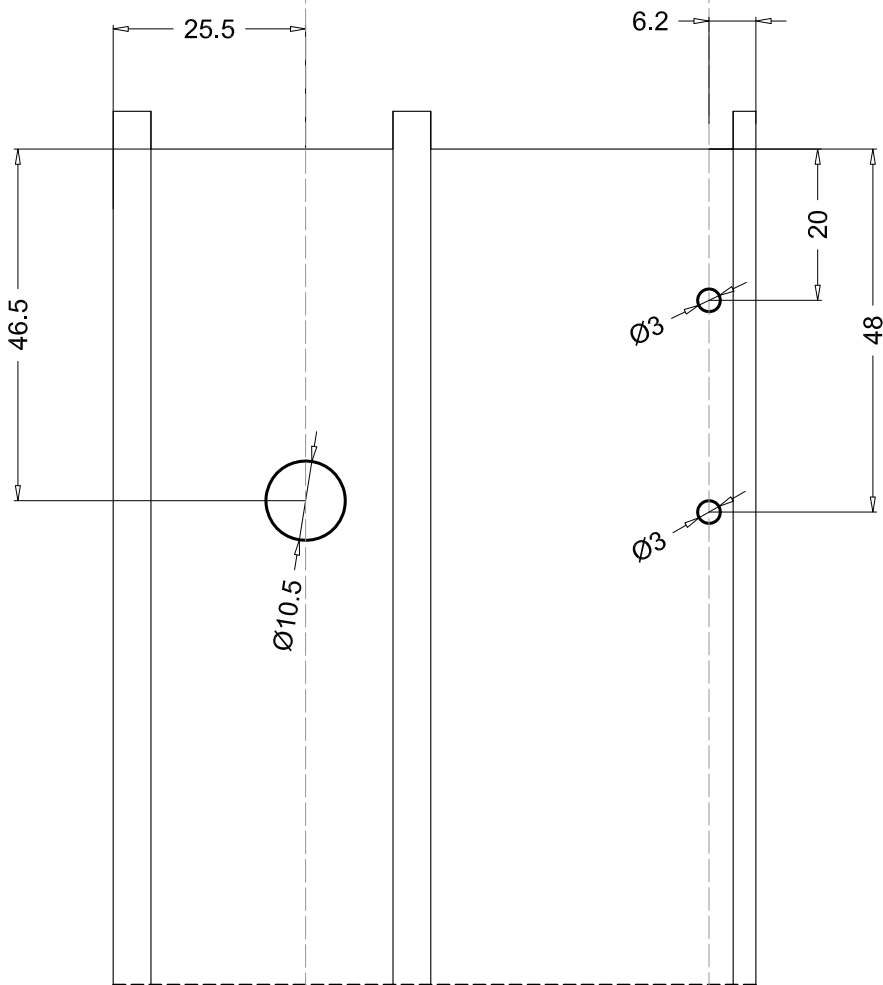
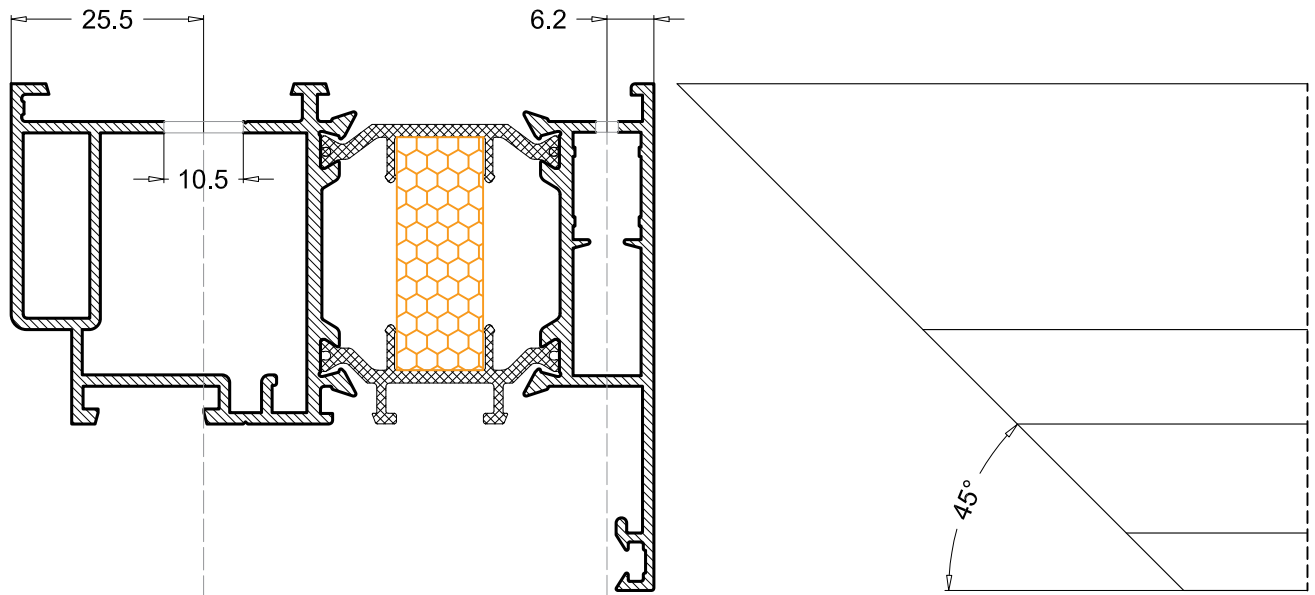

Obrada na profilu PE85206 za montiranje kutnika 5043 i PRA 203

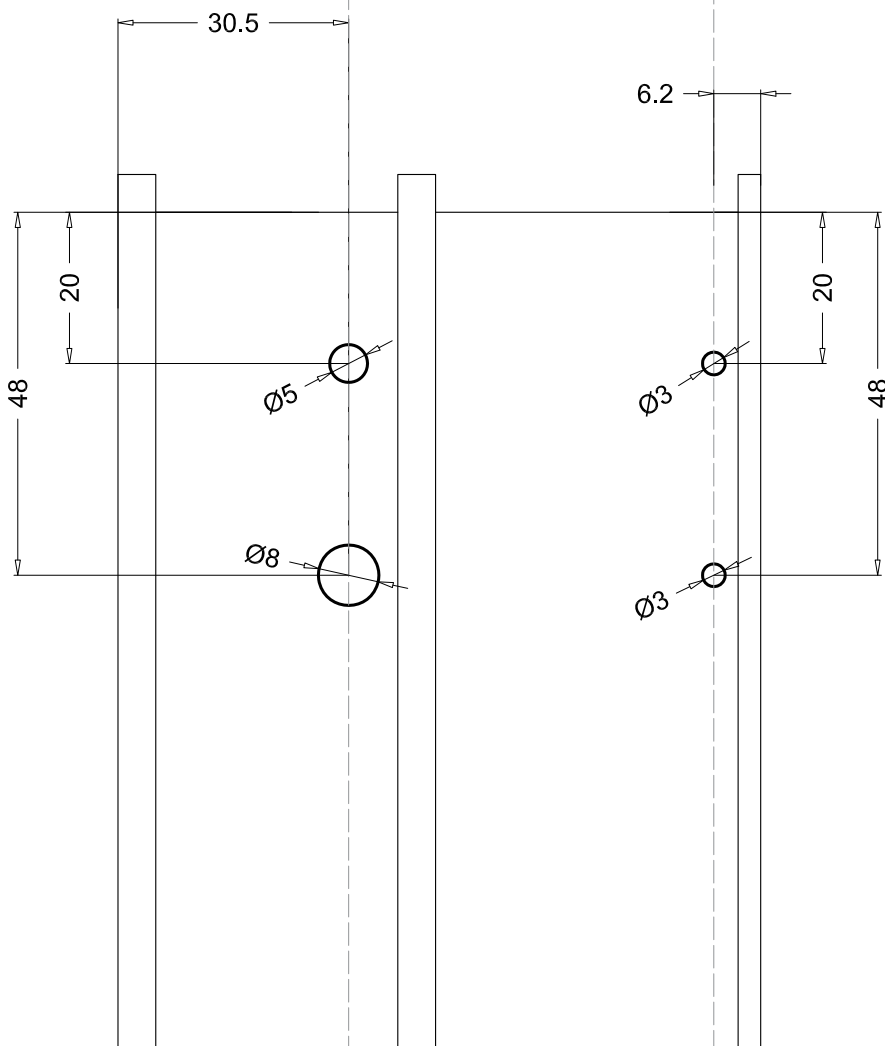
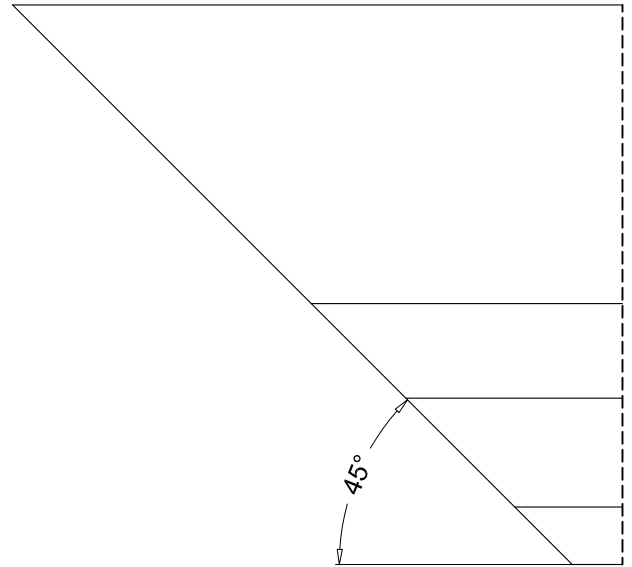
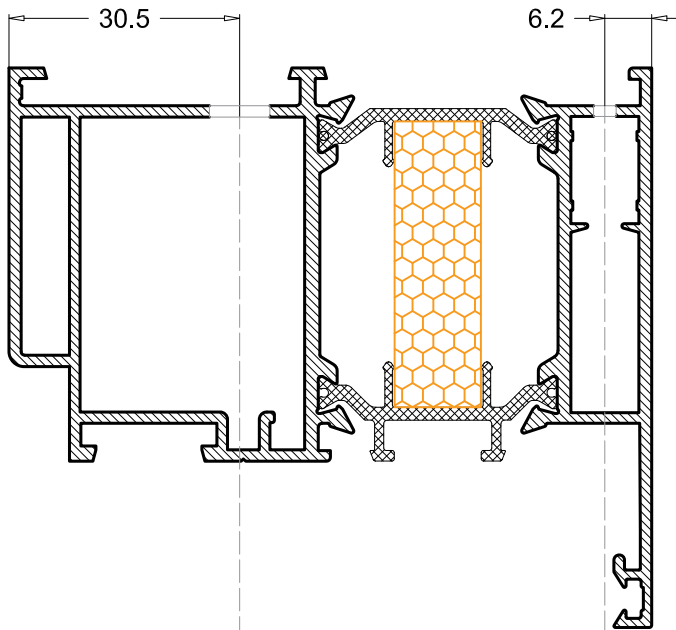



Obrada na profilu PE85214 za montiranje kutnika 5043 i PRA 203

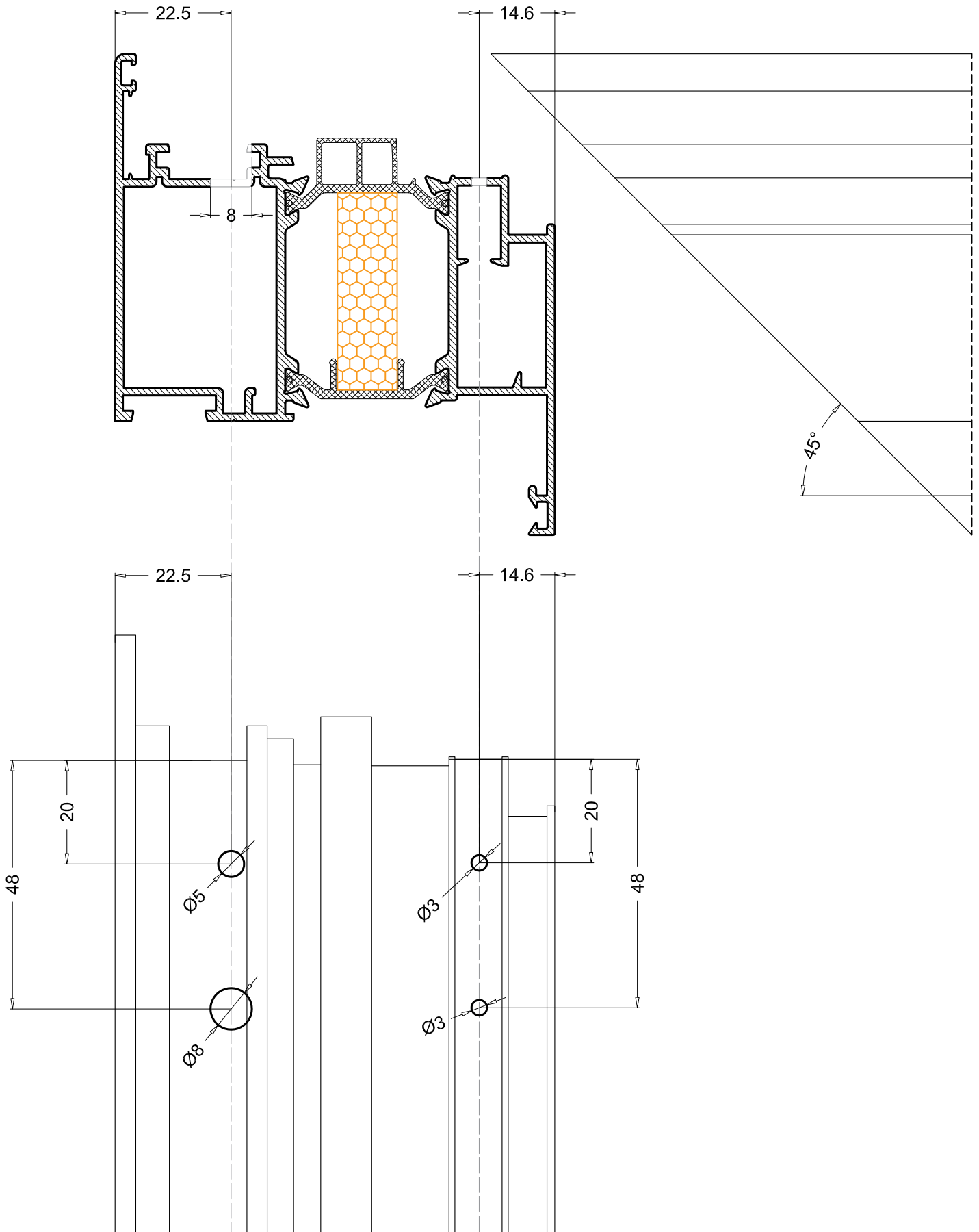

Obrada na profilu PE85212 za montiranje kutnika 5043 i PRA 203

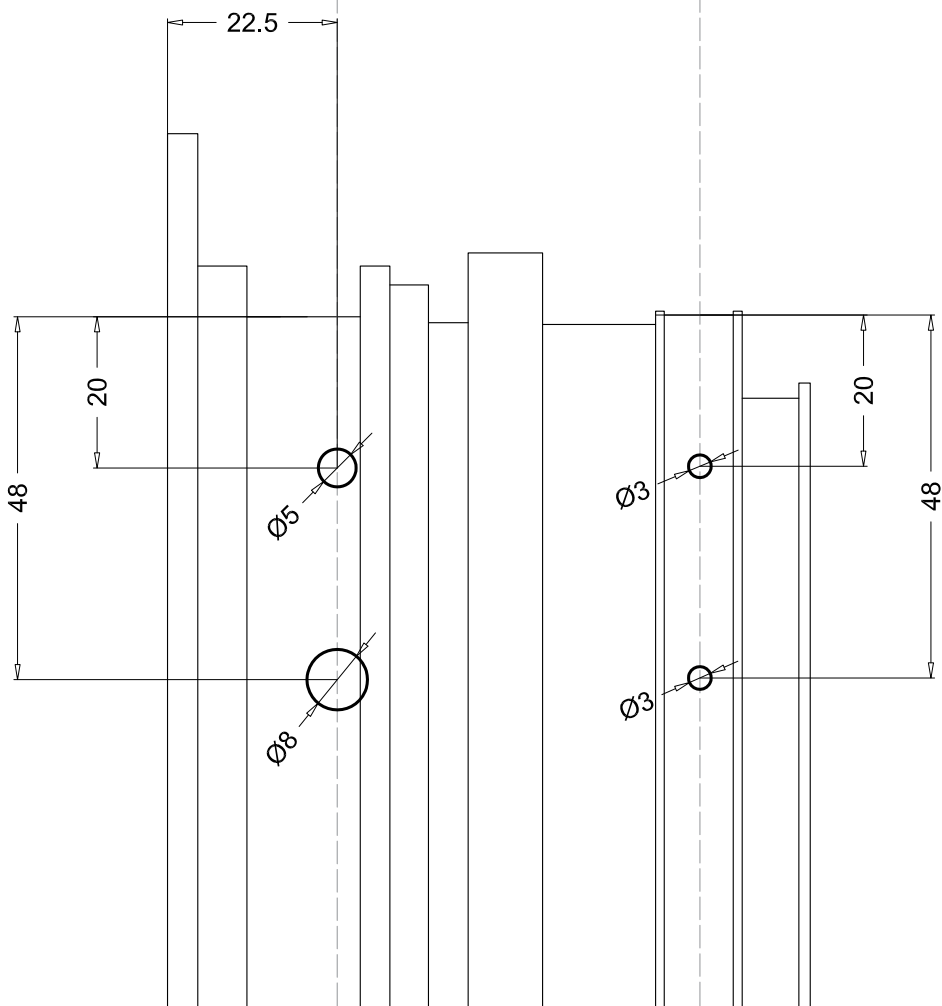
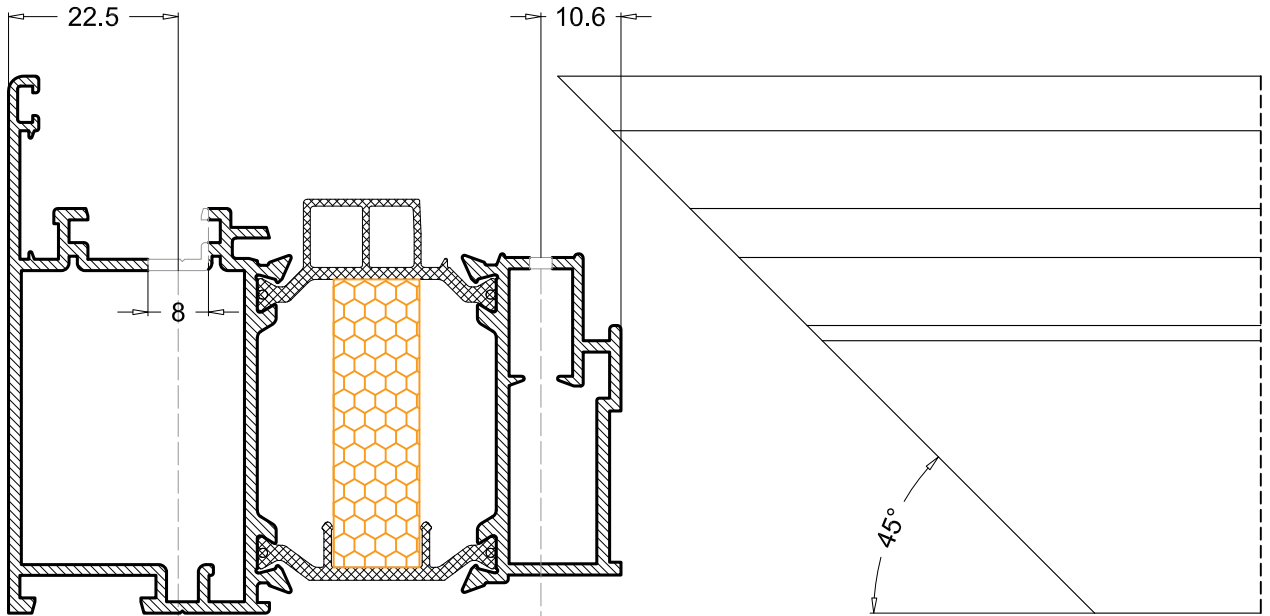

Obrada na profilu klizača PR50550

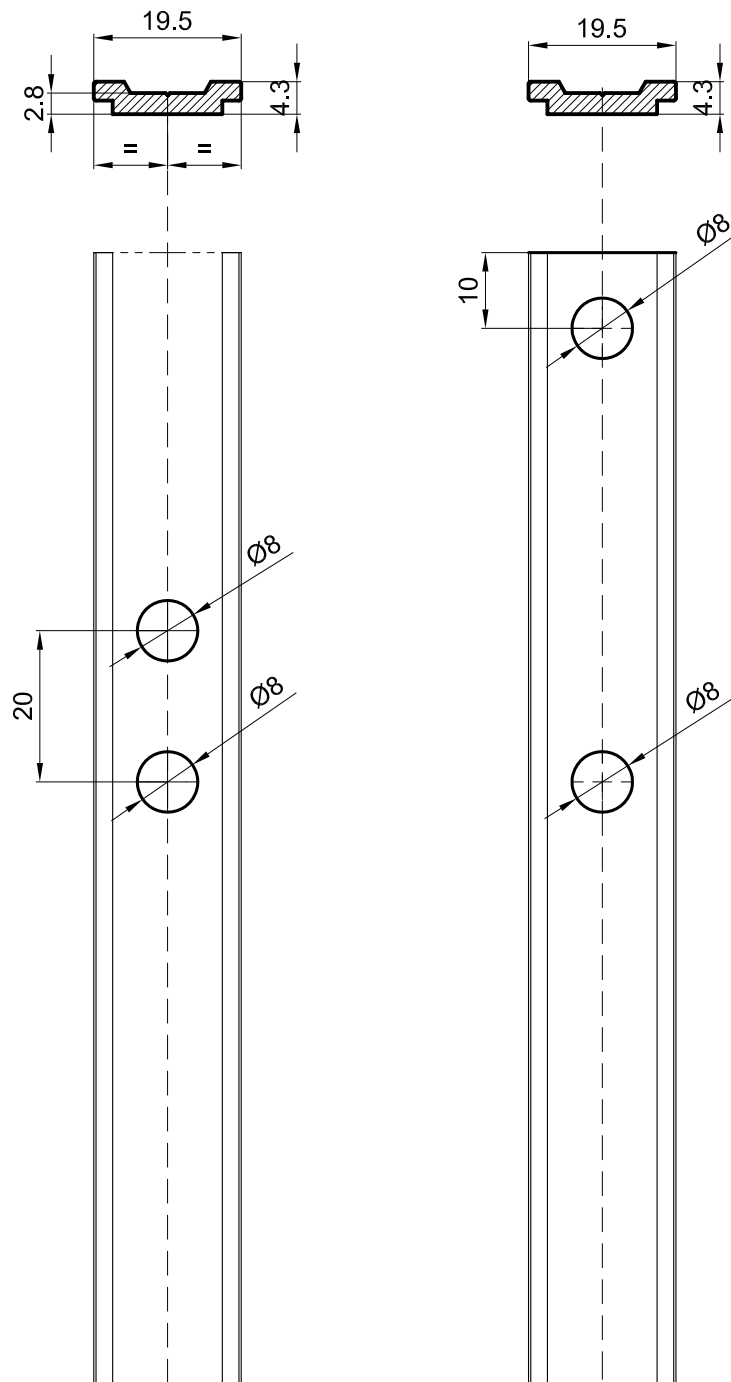

Obrada na profilu okvira za odvod kondenza

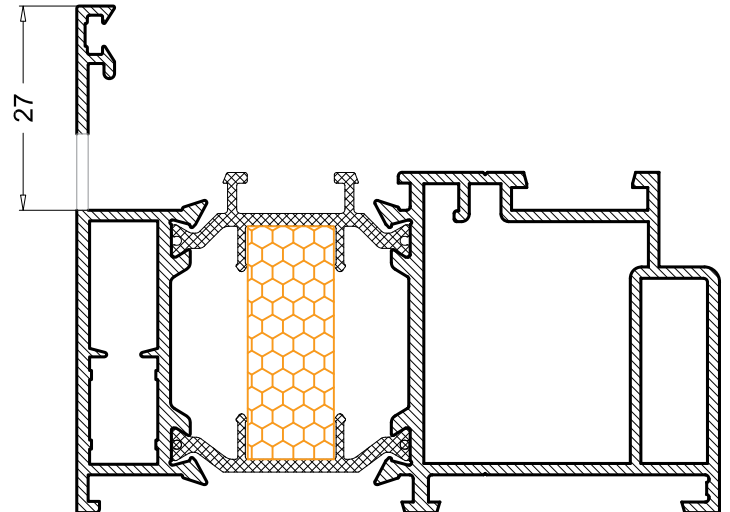
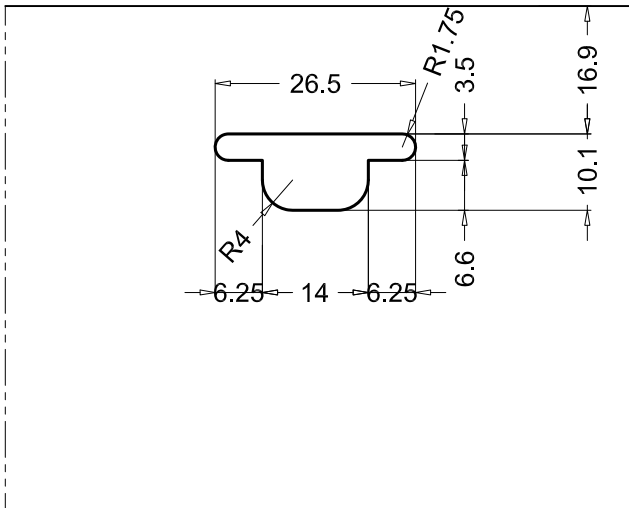

Obrada na profilu okvira za spajanje s pragom

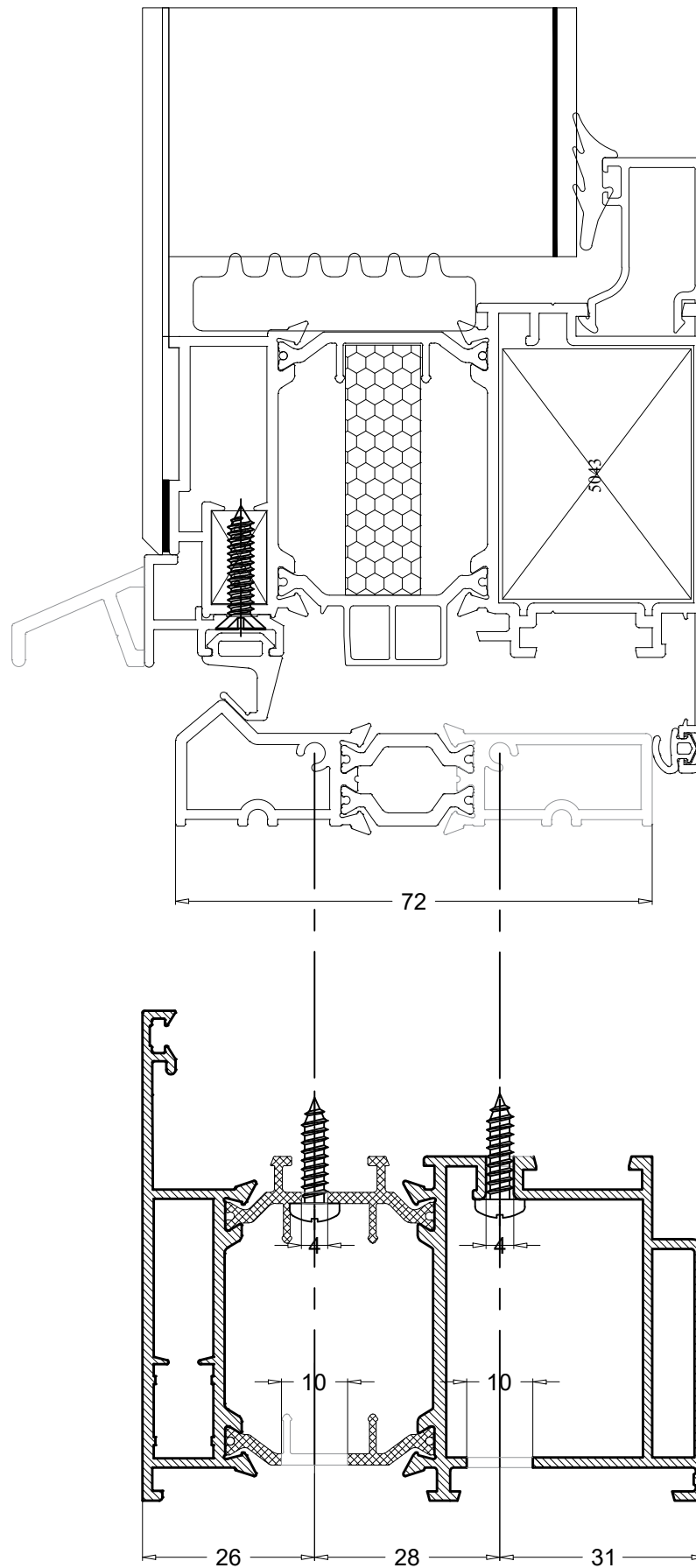

Obrada na profilu PE85235 za spajanje s okvirom

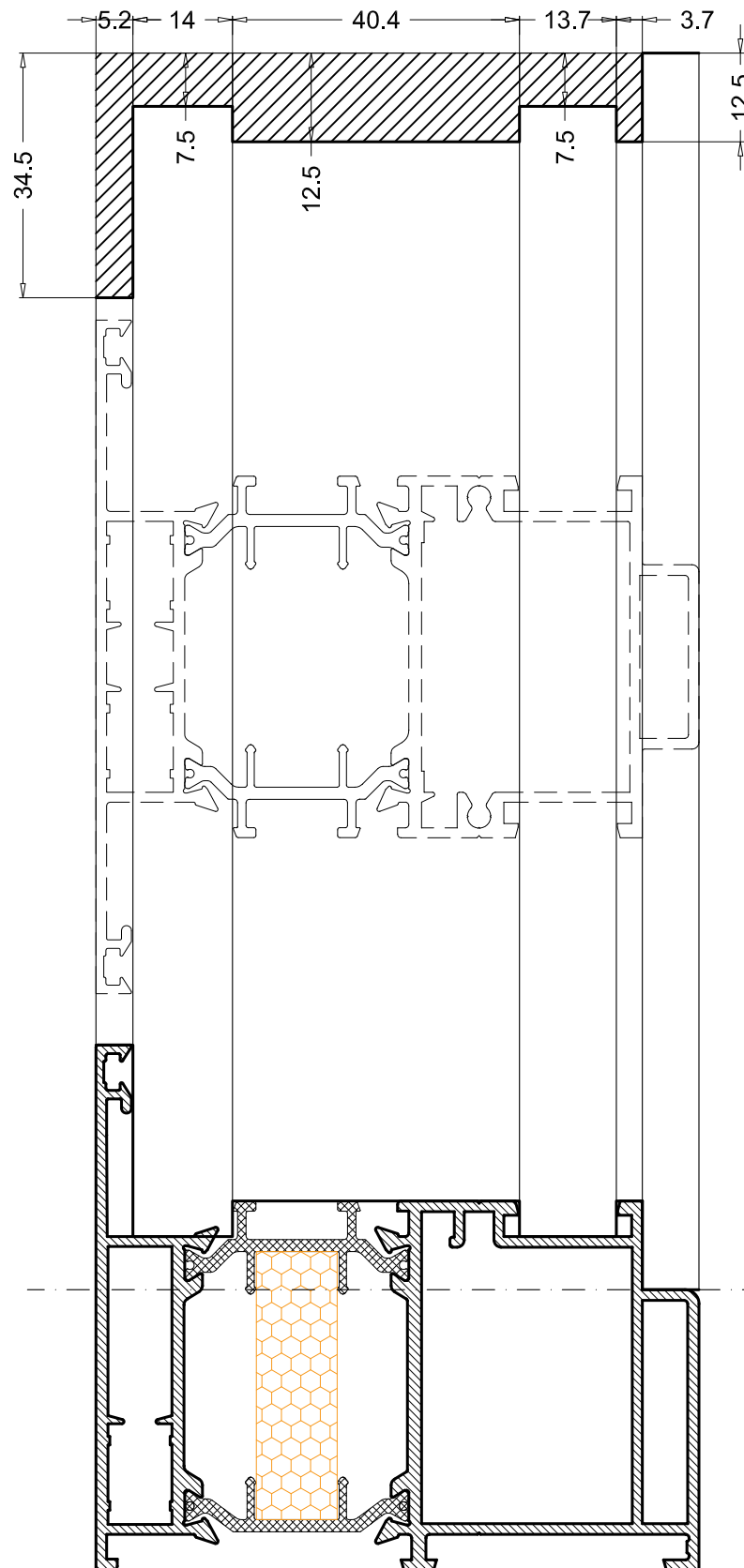

PE85235

PE85206

Obrada na profilu PE85235 za spajanje veznikom G123

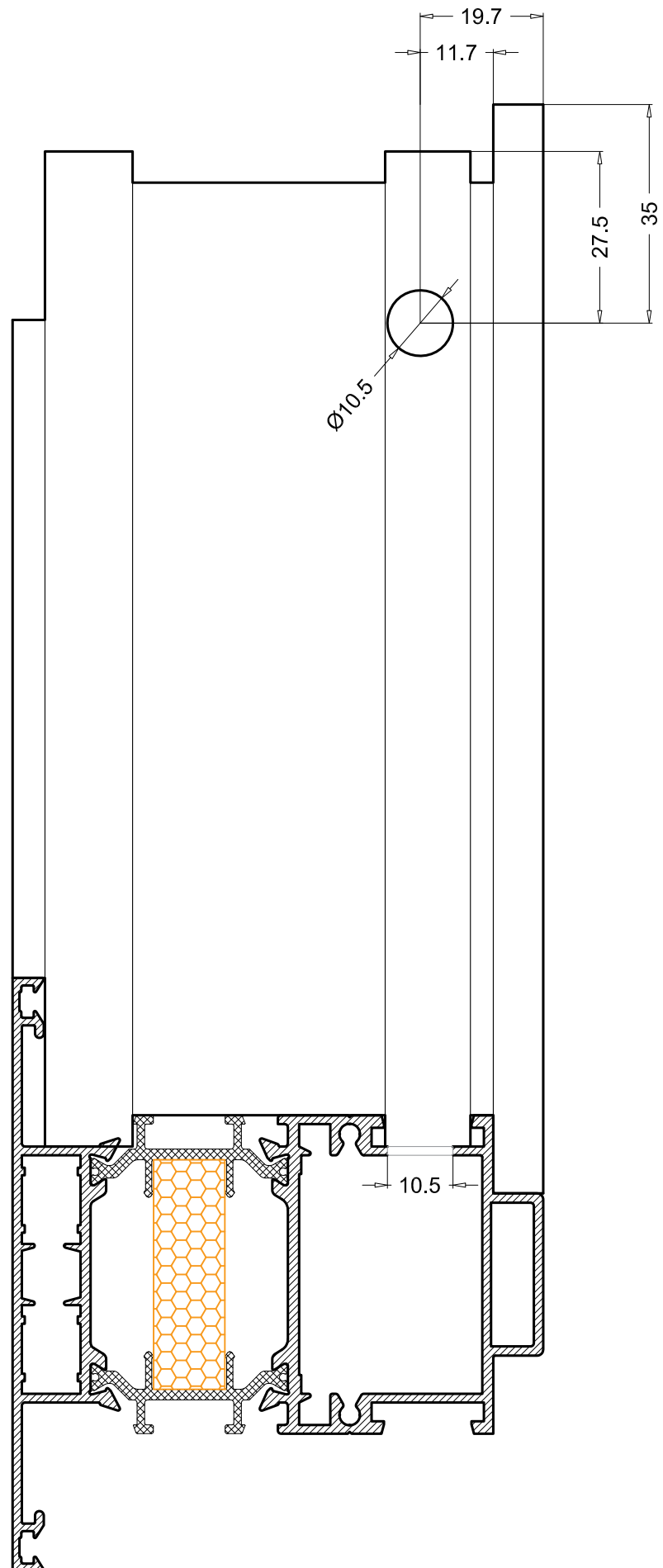



BRTVE I PLASTIKE

KOD	OPIS	Komada po pakovanju	MATERIJAL				
PRG101		Centralna brtva	EPDM+ESPANSO				
						PE75tt	PE85tt
PRG104		Brtva za staklo 5mm	EPDM + ESPANSO				
						PR65tt	PE85tt
Z 921		Brtva za staklo 2-3mm	EPDM				
				PS50	SO49tt	PR65tt	PE85tt
Z 111		Brtva za staklo 2,5-3,5mm	EPDM				
				PS50	SO49tt	PR65tt	PE85tt
Z 918		Brtva za staklo 3,5-4,5mm	EPDM				
				PS50	SO49tt	PR65tt	PE85tt
Z 913		Brtva za staklo 4-5mm	EPDM				
				PS50	SO49tt	PR65tt	PE85tt
PRG 05		Brtva krila	EPDM				
					PS50	SO49tt	PR65tt
PRG 21		Brtva praga	EPDM				

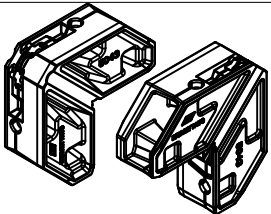
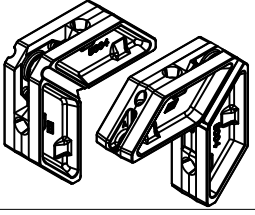

## BRTVE I PLASTIKE

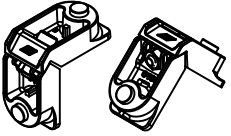
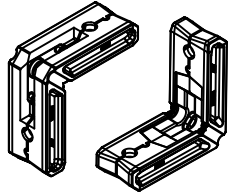
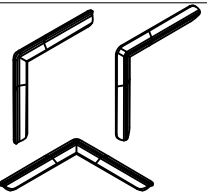
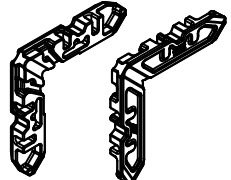
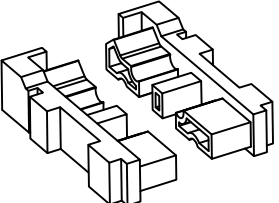
KOD	OPIS	Komada po pakovanju	MATERIJAL				
5043	 <p style="text-align: center;">Tonale kutnik 29 mm x 38.5 mm</p>		Aluminijski odlivak				
							PE85tt
5004	 <p style="text-align: center;">Tonale kutnik 26.8 mm x 31.4 mm</p>		Aluminijski odlivak				
							PE85tt
PRA02	 <p style="text-align: center;">Kutnik poravnanja pokretnog krila 4.8mm x 17.4 mm</p>		Aluminijski odlivak				
				PR65tt	PE66tt	PE75tt	PE85tt
PRA200	 <p style="text-align: center;">Kutnik sa dugmetom 28.5 mm x 14.5 mm</p>		Aluminijski odlivak				
				PR65tt	PE66tt	PE75tt	PE85tt
5011	 <p style="text-align: center;">Tonale kutnik 28.5 mm x 14.5 mm</p>		Aluminijski odlivak				
				PR65tt	PE66tt	PE75tt	PE85tt
PRA 14	 <p style="text-align: center;">Kutnik poravnanja štoka/krila</p>		Aluminijski odlivak				
			PS50	SO49tt	PR65tt	PE66tt	PE75tt
PRA 203	 <p style="text-align: center;">Kutnik poravnanja štoka/krila</p>		Aluminijski odlivak				
							PE85tt
PRG XX	 <p style="text-align: center;">Čep za prag</p>		PVC				
							PE85tt