



**EMERUS**

ALUMINIUM EXTRUSION







**PS15**

Grilje

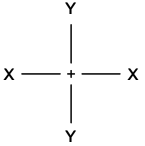
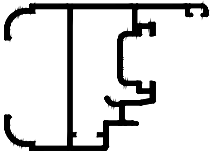
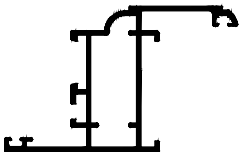
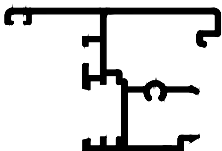
**TEHNIČKI KATALOG**

**PROFILI**

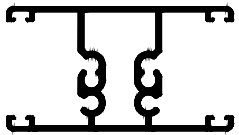
Kod Codice Code	Presjek Sezione Cross Section 	Težina Peso Weight <i>Kg/m</i>	Perimetar Perimetro Perimeter mm	Vidljiva površina Sup. in Vista Exposed surface mm	Jx <i>cm<sup>4</sup></i>	Wx <i>cm<sup>3</sup></i>	Jy <i>cm<sup>4</sup></i>	Wy <i>cm<sup>3</sup></i>
PS15005		1.042	530.7	138.03	12.02	4.43	10.09	2.76
PS15006		0.978	488.2	121.44	11.97	4.95	10.67	2.68
PS15007		0.878	433.06	93.782	7.41	2.61	6.62	1.92
PS15008		0.394	163.25	35.94	0.7	0.5	0.87	0.62
PS15003		0.382	230.6	107.38	3.02	1.11	0.33	0.49
PS15004		0.484	304.9	117.5	7.37	2.18	0.47	0.49
PS15600		1.663	739.13	269.6	11.57	6.93	93.0	14.53
PS15602		0.954	478.6	250.0	7.80	2.60	5.70	3.30



PROFILI

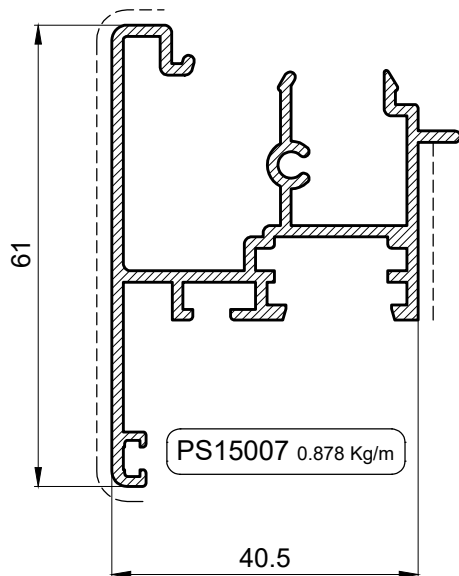
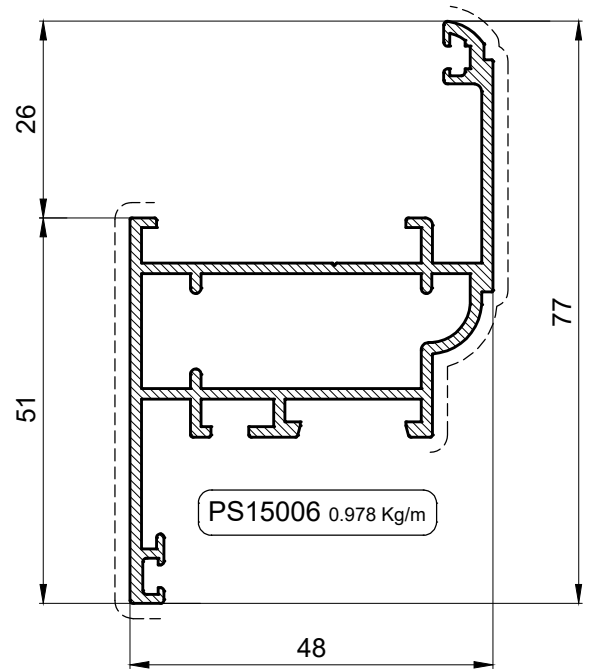
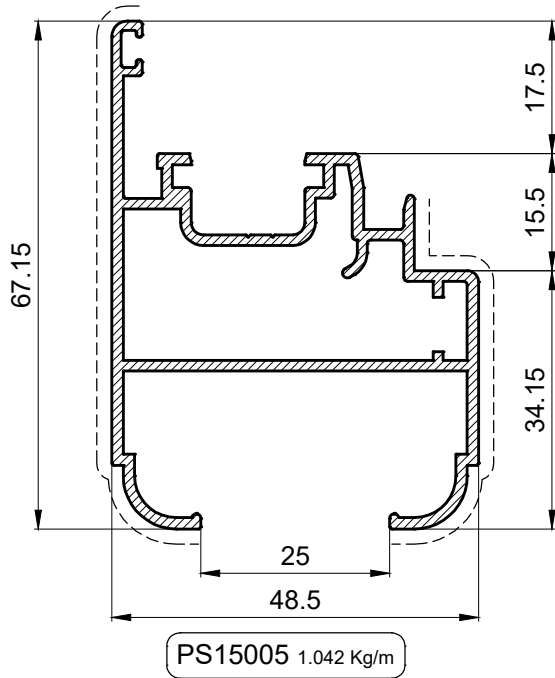

PROFILI

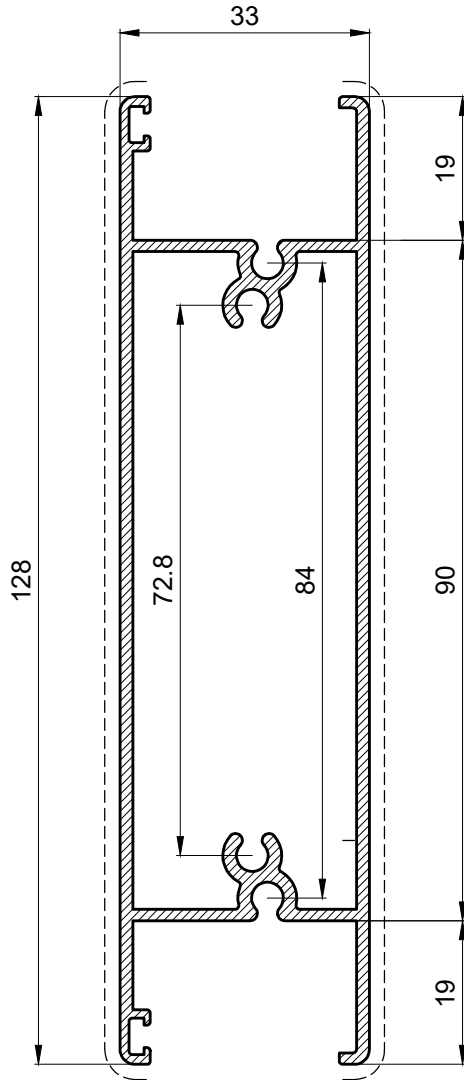

PS15600 1.663 Kg/m

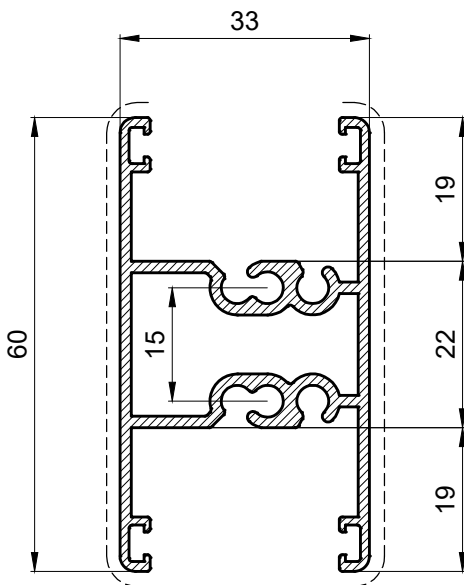

PS15062 0.954 Kg/m

PROFILI

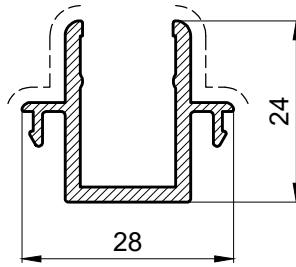

PS15008 0.394 Kg/m

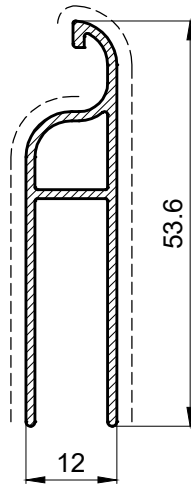

PS15003 0.382 Kg/m

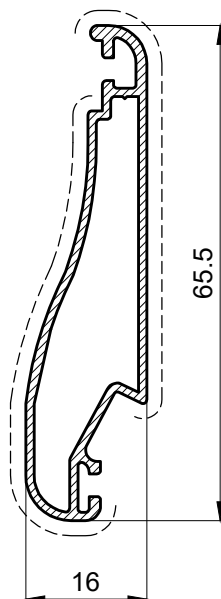

PS15004 0.484 Kg/m

PROFILI

PS14718 0.983 Kg/m

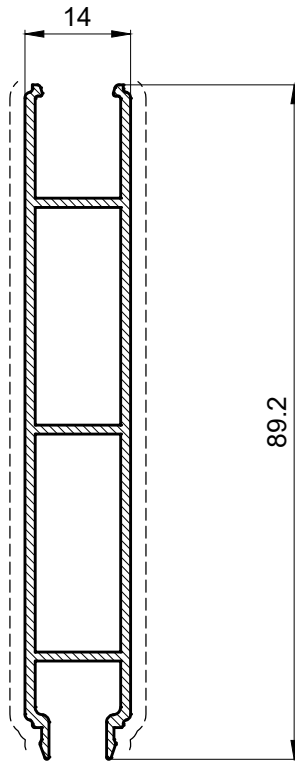

PS20002 0.382 Kg/m

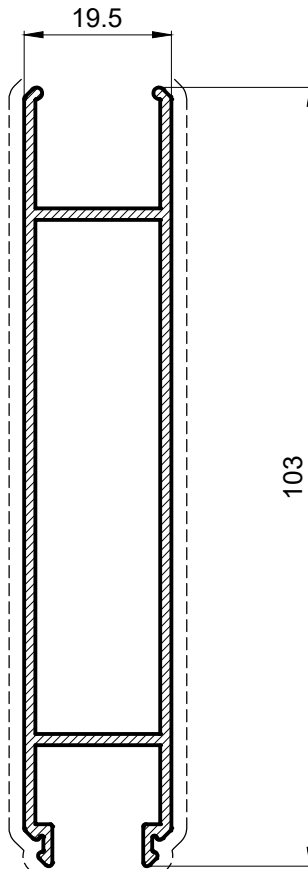

PRESJECI

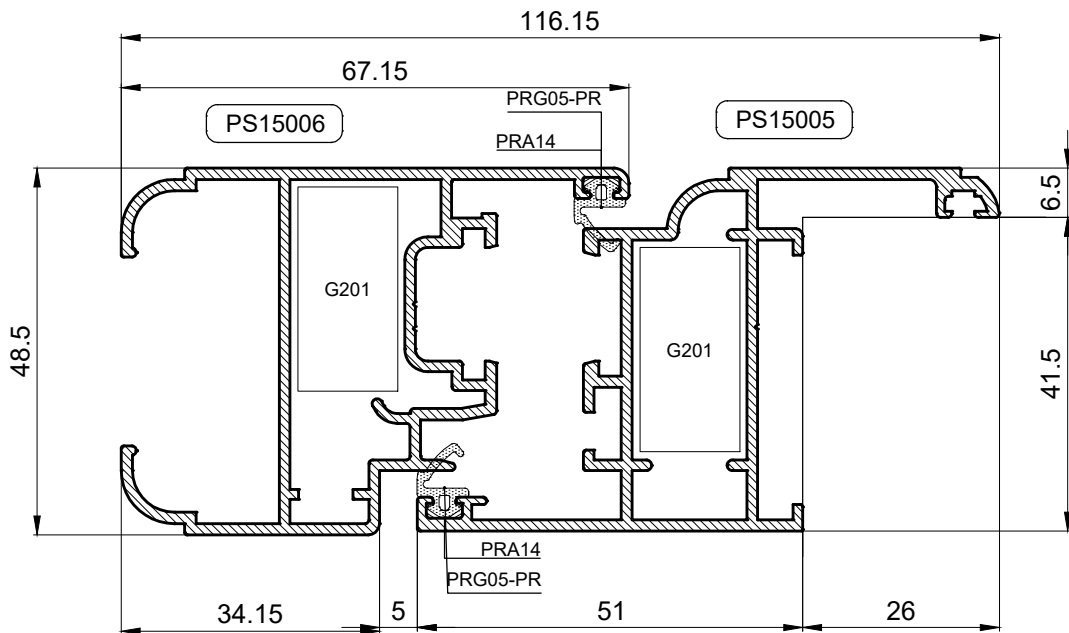
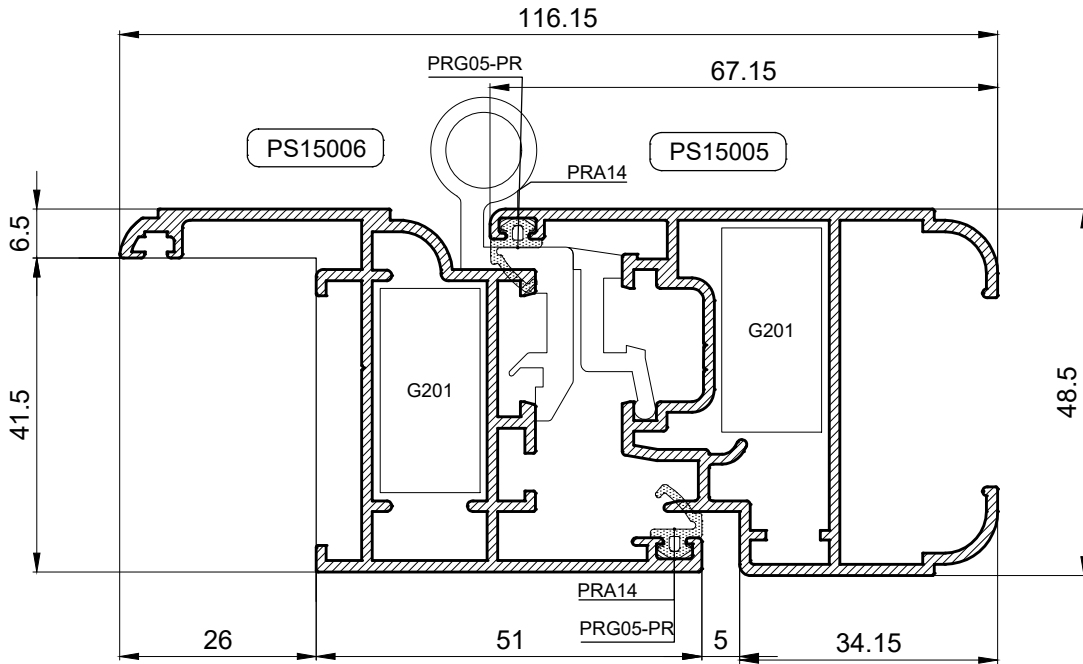
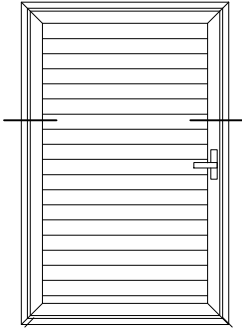



PRESJECI

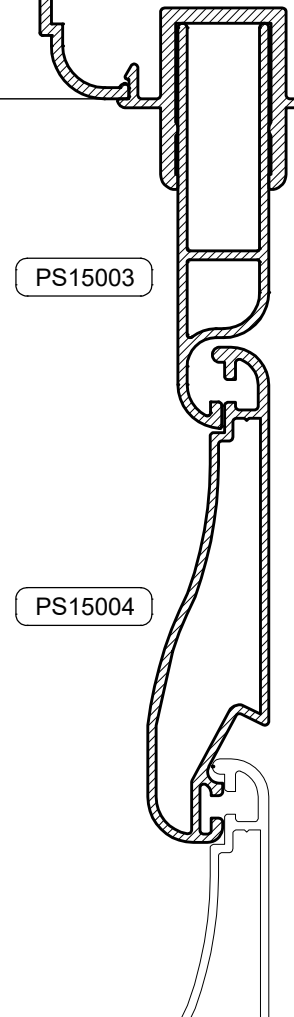
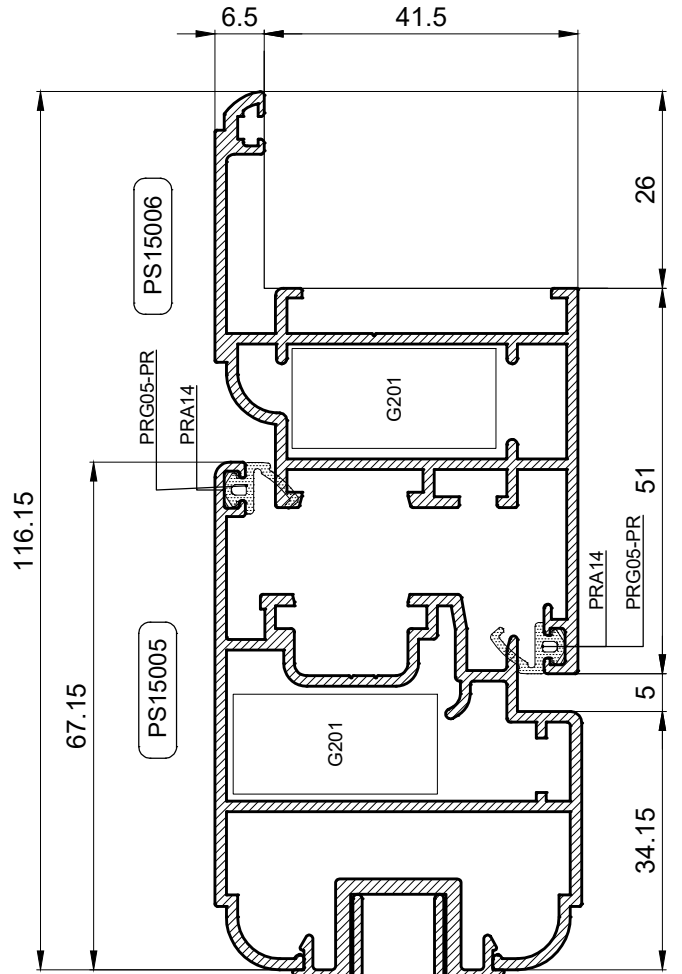
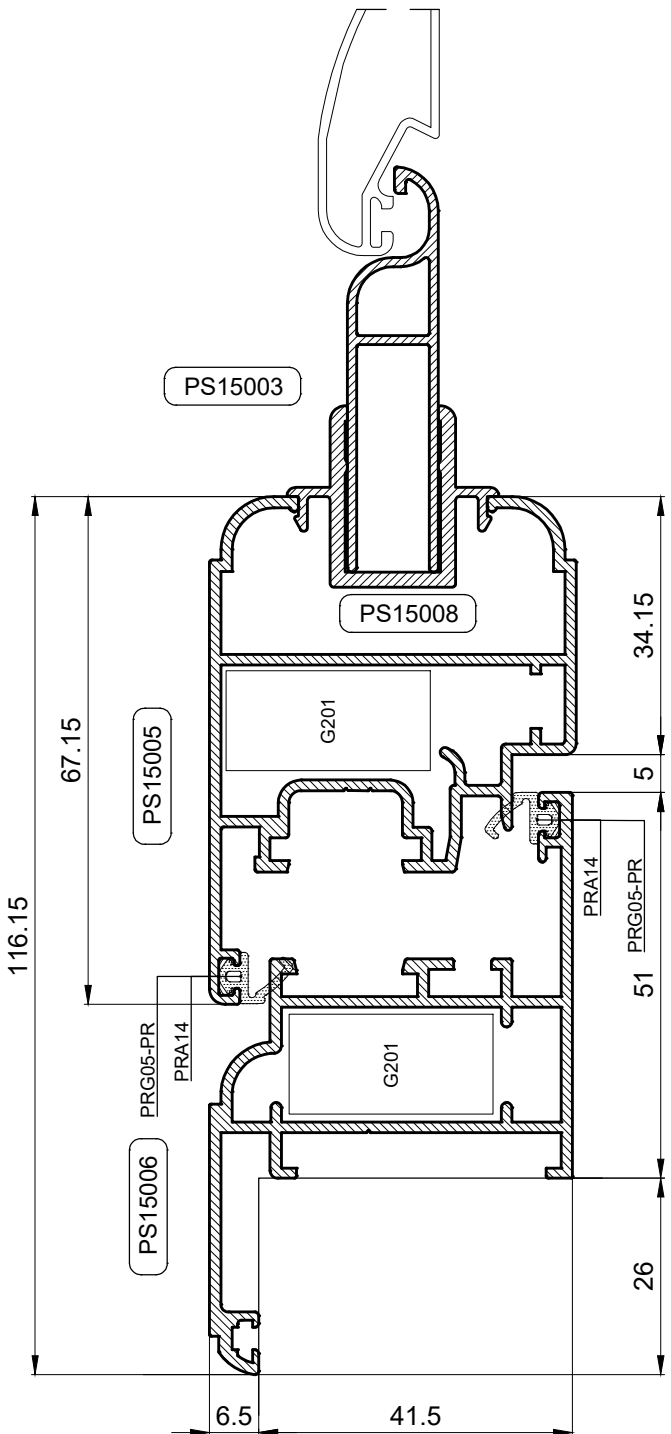
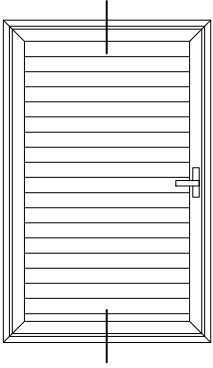

PRESJECI

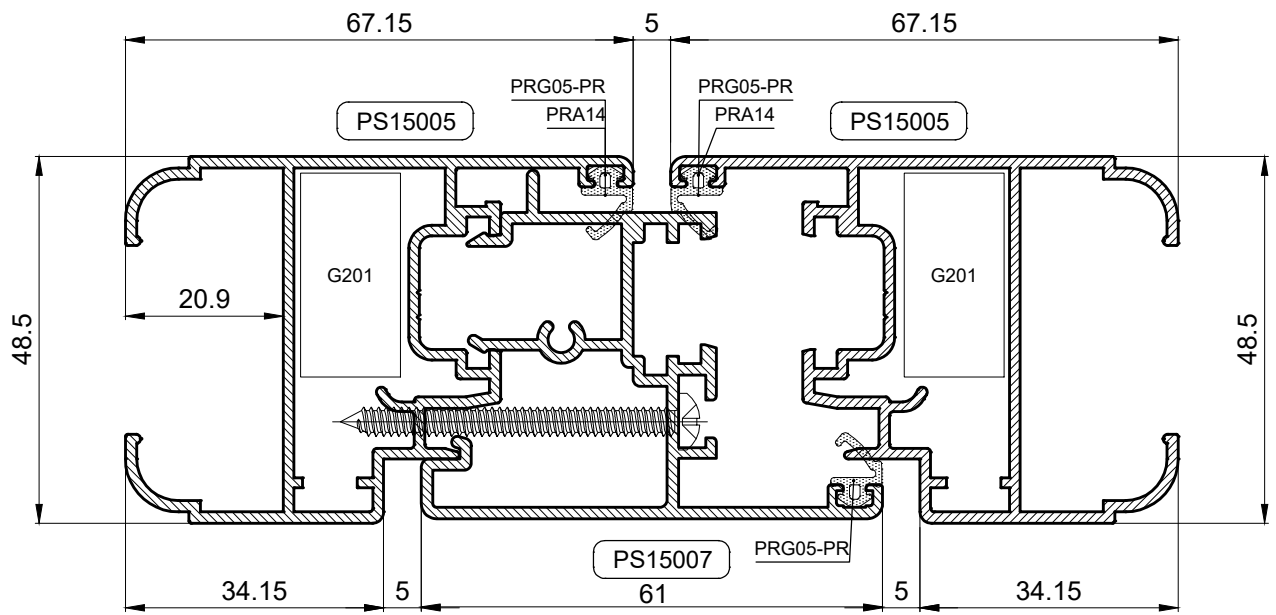
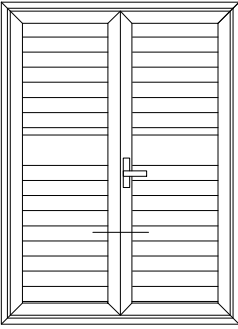

PRESJECI

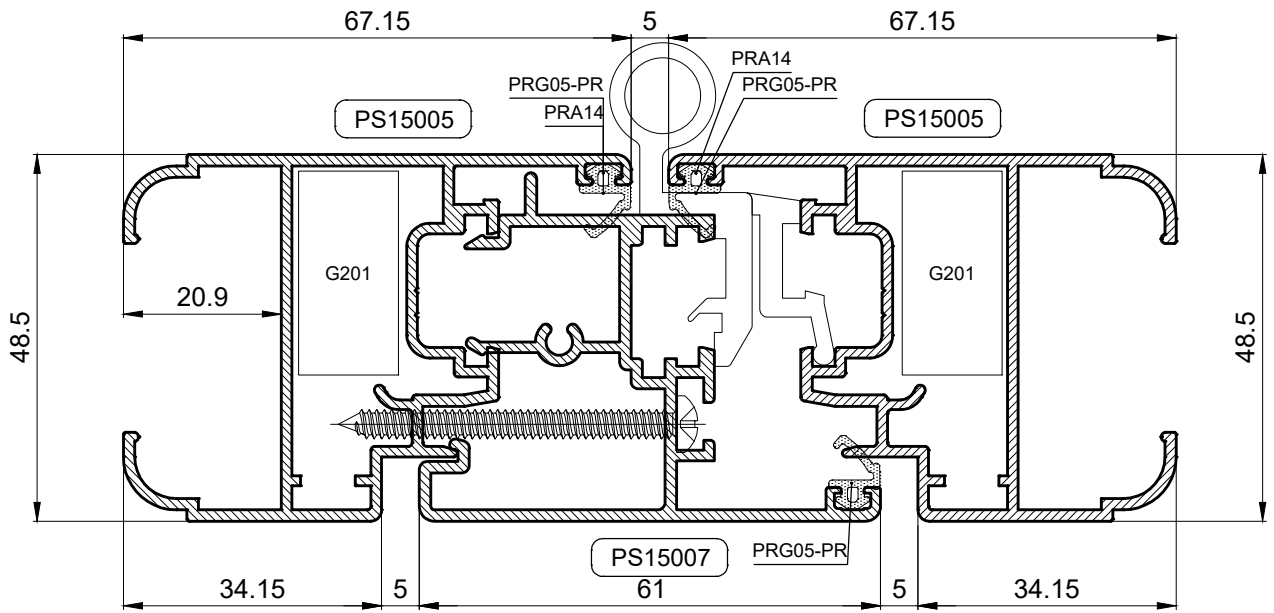
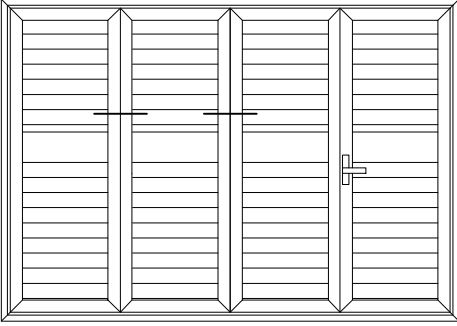

PRESJECI

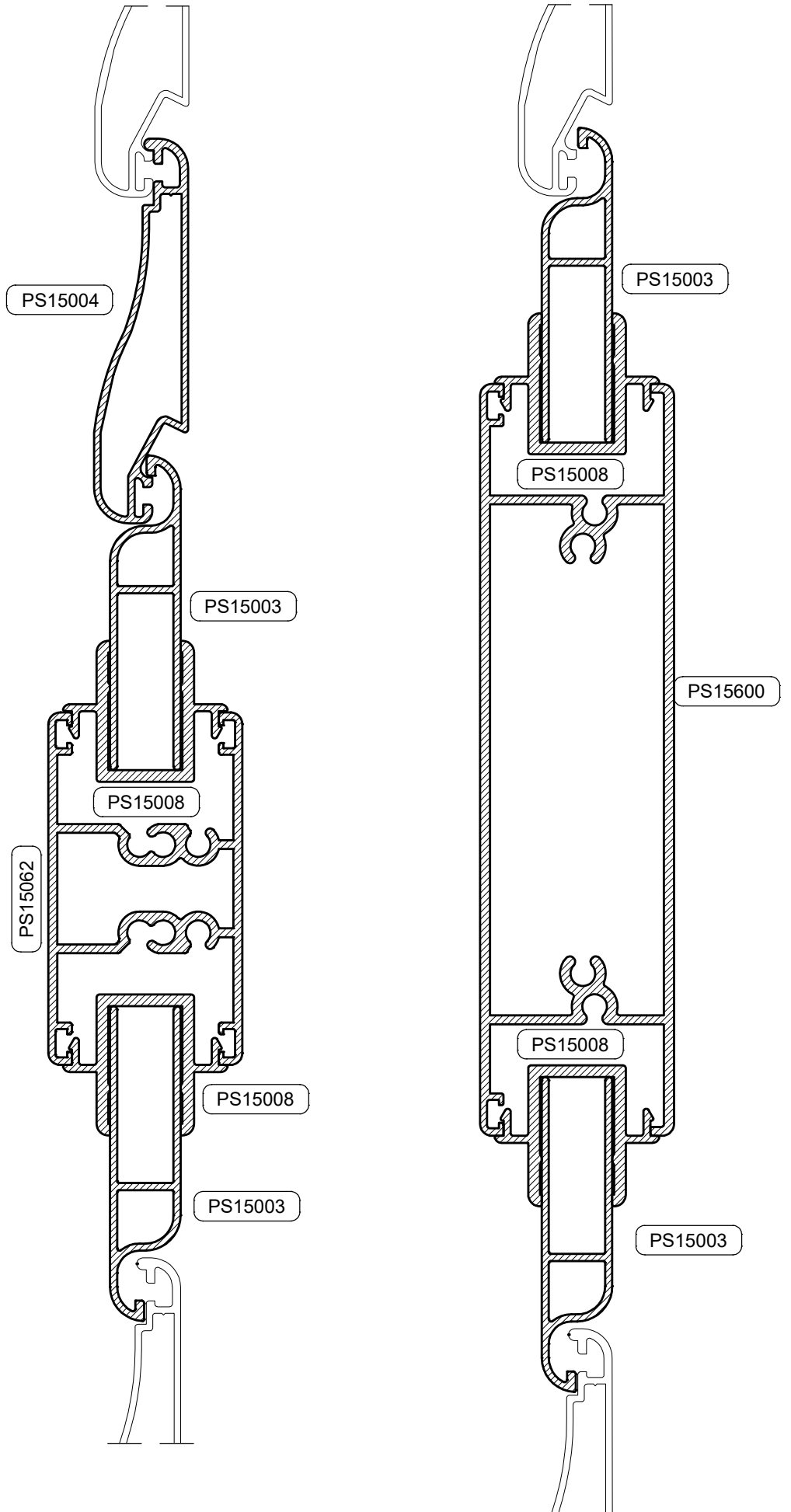
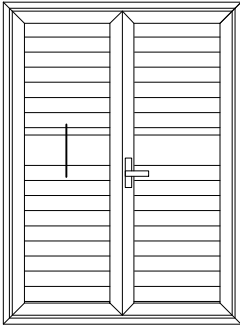

PRESJECI

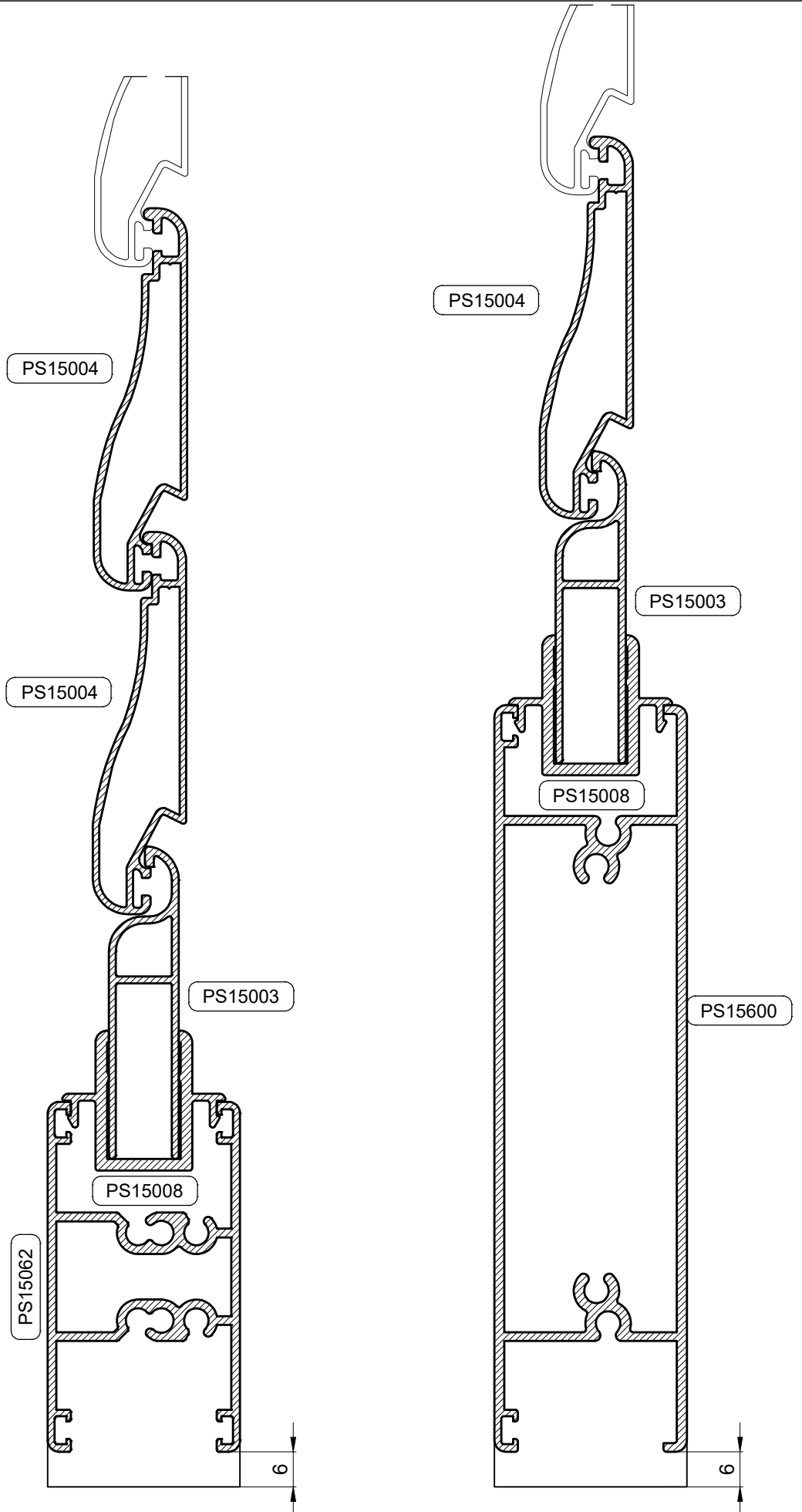
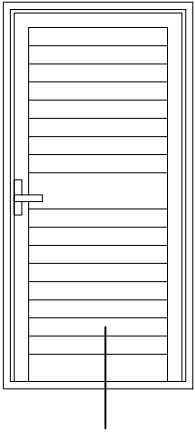

PRESJECI

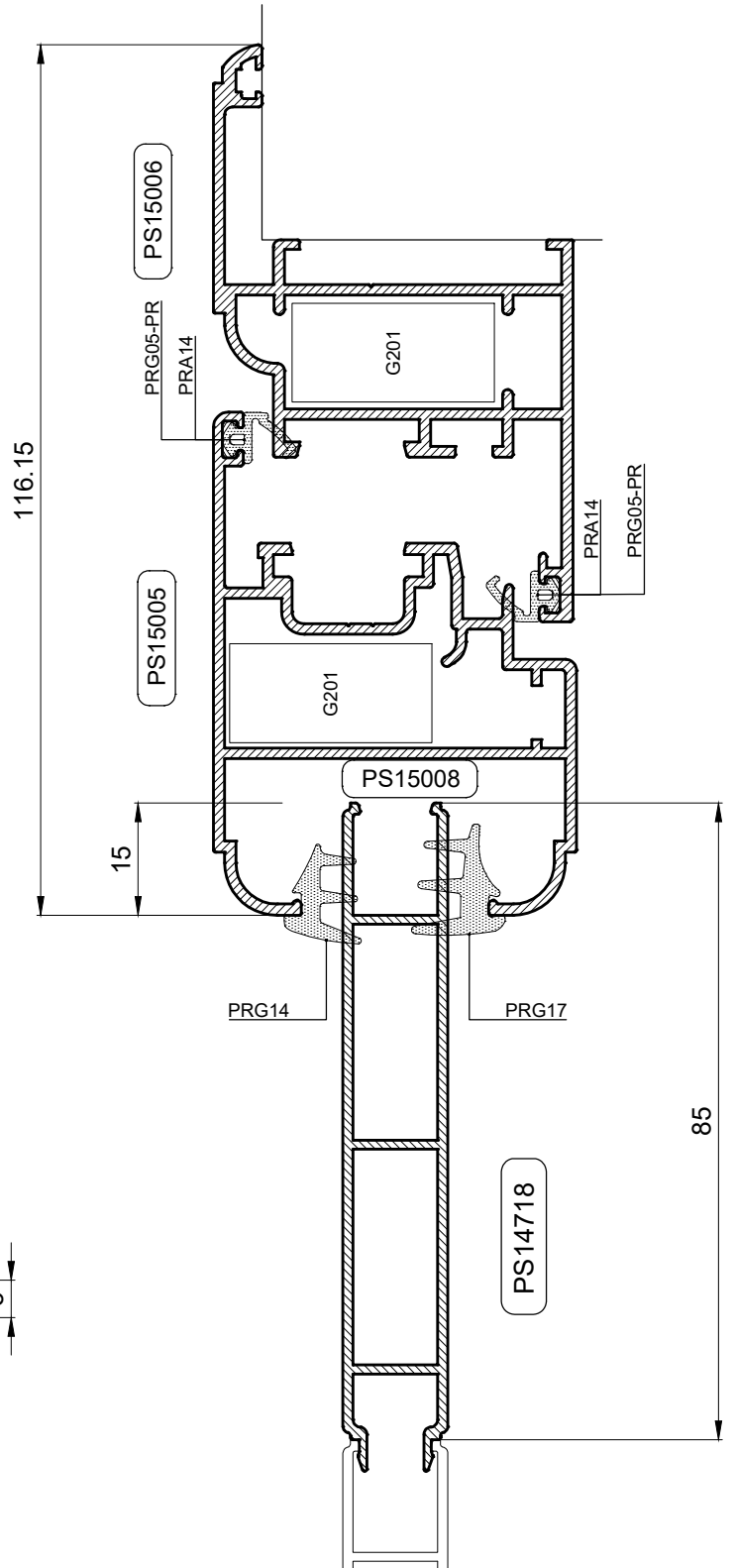
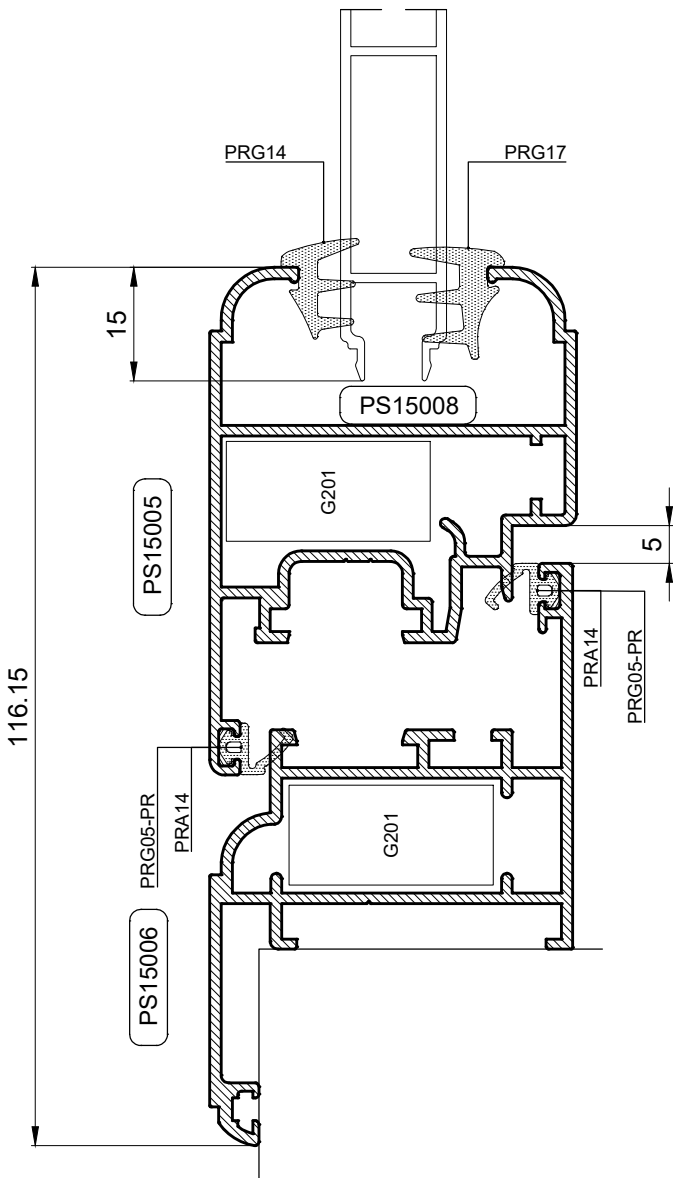
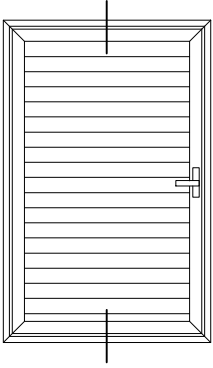

## PRESJECI

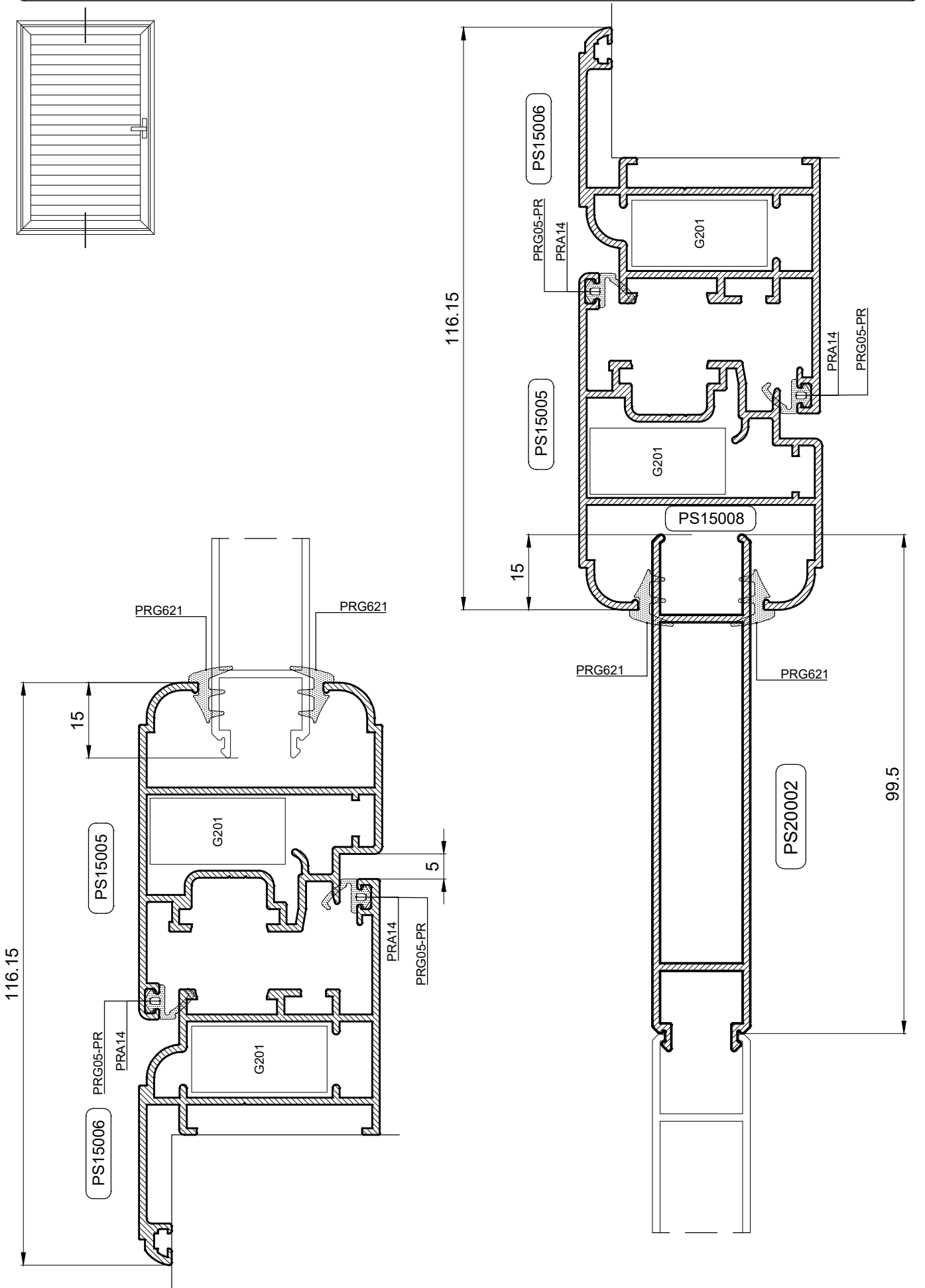
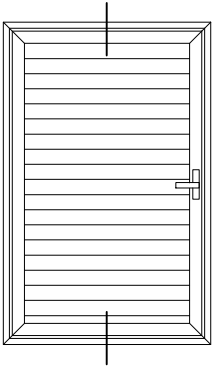

**REZNE LISTE - Jednokrilna prozorska grilja**

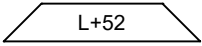
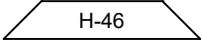
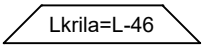
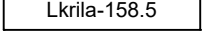
KOD	PROFIL	BR. KOM	REZANJE
PS 15006	OKOMICA OKVIRA	2	
PS 15006	GORNJA VODORAVNICA OKVIRA	1	
PS 15006	DONJA VODORAVNICA OKVIRA	1	
PS 15005	OKOMICA KRILA	2	
PS 15005	VODORAVNICA KRILA	2	
PS 15008	NOSAČ POČETNE LAMELE	2	
PS 15003	POČETNA LAMELA	2	
PS 15004	LAMELA	nLU	

nLI - Izračunati broj lamela  
nLU - Usvojeni broj lamela  
H - visina građevinskog otvora  
Hs - visina skraćena početne lamele

$$nLI=(H-256):55$$

Dobiveni broj lamela zaokružuje se na veći cijeli broj(nLU).

Nakon izračuna radi se korekcija visine početne i krajnje lamele po formuli:

$$Hs=(nLU-nLI) \times 55/2$$

\*U katalogu se prikazani kodovi za crnu verziju okova.

Kodovi za bijelu verziju okova su:

ET0361- Ručica, bijela

ET0458- Mehanizam, bijeli

GS01004- Ručka, bijela

GS0121- Baglama, bijela

R000408- TMS NSUP 9010- Držac grilje, dugi

KOD	OKOVI	BR. KOM	NOTE
G 201	KUTNIK OKVIRA/KRILA	8	
PRA 14	KUTNIK PORAVNANJA KRILA/OKVIRA	8	

KOD	BRTVE/ČEPOVI	BR. KOM	NOTE
PRG05-PR	BRTVA OKVIRA/KRILA	8	4L + 4H
10469	BRTVA LAMELE GRILJE	nL	4L + 4H

KOD	OKOV I PRIBOR	BR. KOM	NOTE
ET0369	RUČICA, CRNA	1	
ET0376	MEHANIZAM, CRNI	1	H
GS01004	RUČKA, CRNA	1	
GS0121	BAGLAMA, CRNA	3	
GS1314	PRIHVATNIK KRAKUNA	2	
GS2114	ZAPINJAČ KRAJNJI	2	
GS2260	SET ZA RUČKU	1	
R000407	TMS NSUP 9005- DRŽAČ GRILJE, DUGI	1	



REZNE LISTE - Jednokrilna prozorska grilja

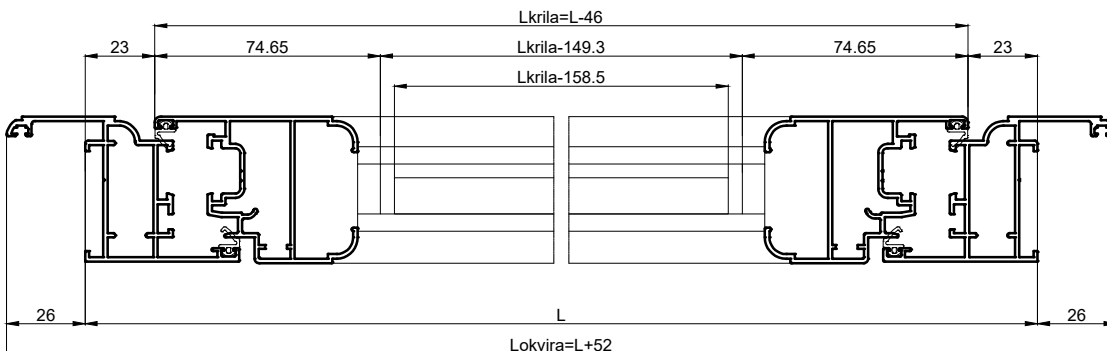
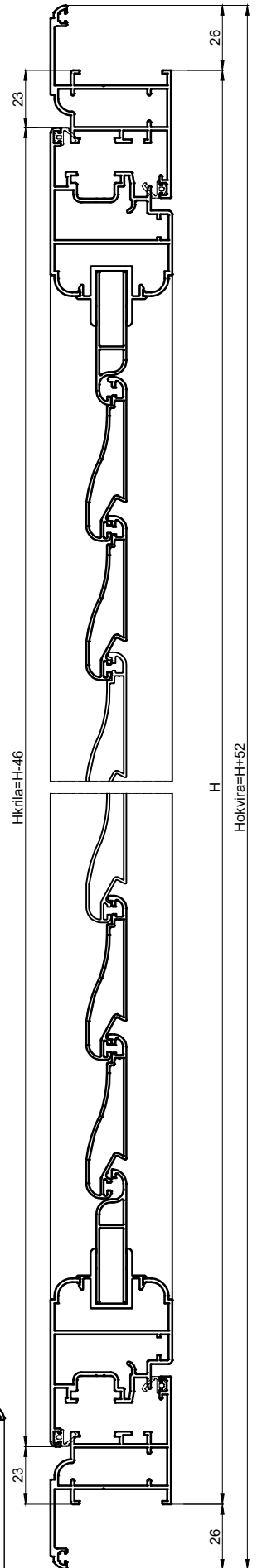
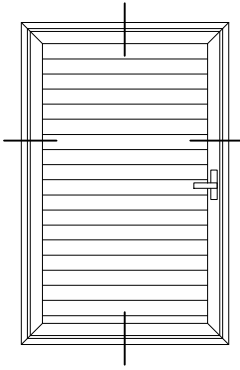

**REZNE LISTE - Dvokrilna prozorska grilja**

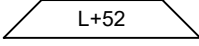
KOD	PROFIL	BR. KOM	REZANJE
PS 15006	OKOMICA OKVIRA	2	 H+52
PS 15006	GORNJA VODORAVNICA OKVIRA	1	 L+52
PS 15006	DONJA VODORAVNICA OKVIRA	1	 L+52
PS 15005	OKOMICA KRILA	4	 H-46
PS 15005	VODORAVNICA KRILA	4	 Lkrila=L/2-25.5
PS 15007	CENTRALNI PROFIL	1	 H-112
PS 15008	NOSAČ POČETNE LAMELE	4	 Lkrila-158.5
PS 15003	POČETNA LAMELA	4	 Lkrila-158.5
PS 15004	LAMELA	nLU	 Lkrila-149.3

nLI - Izračunati broj lamela  
nLU - Usvojeni broj lamela  
H - visina građevinskog otvora  
Hs - visina skraćenja početne lamele

$$nLI=(H-256):55$$

Dobiveni broj lamela zaokružuje se na veći cijeli broj(nLU).

Nakon izračuna radi se korekcija visine početne i krajnje lamele po formuli:

$$Hs=(nLU-nLI) \times 55/2$$

\*U katalogu se prikazani kodovi za crnu verziju okova.

Kodovi za bijelu verziju okova su:

ET0361- Ručica, bijela

ET0458- Mehanizam, bijeli

GS01004- Ručka, bijela

GS0121- Baglama, bijela

R000408- TMS NSUP 9010- Držac grilje, dugi

KOD	OKOVI	BR. KOM	NOTE
G 201	KUTNIK OKVIRA/KRILA	12	
PRA 14	KUTNIK PORAVNANJA KRILA/OKVIRA	12	
GS2273	KAPA ZA CENTRALNI PROFIL GRILJE	1	

KOD	BRTVE/ČEPOVI	BR. KOM	NOTE
PRG05-PR	BRTVA OKVIRA/KRILA	11	4L + 7H

KOD	OKOV I PRIBOR	BR. KOM	NOTE
ET0369	RUČICA, CRNA	2	
ET0376	MEHANIZAM, CRNI	2	H
GS01004	RUČKA, CRNA	1	
GS0121	BAGLAMA, CRNA	6	
GS1339	DUPLI PRIHVATNIK	2	
GS2111	KRAKUN	2	
GS2114	ZAPINJAČ KRAJNJI	2	
GS2260	SET ZA RUČKU	1	
R000407	TMS NSUP 9005- DRŽAČ GRILJE, DUGI	2	

## REZNE LISTE - Dvokrilna prozorska grilja

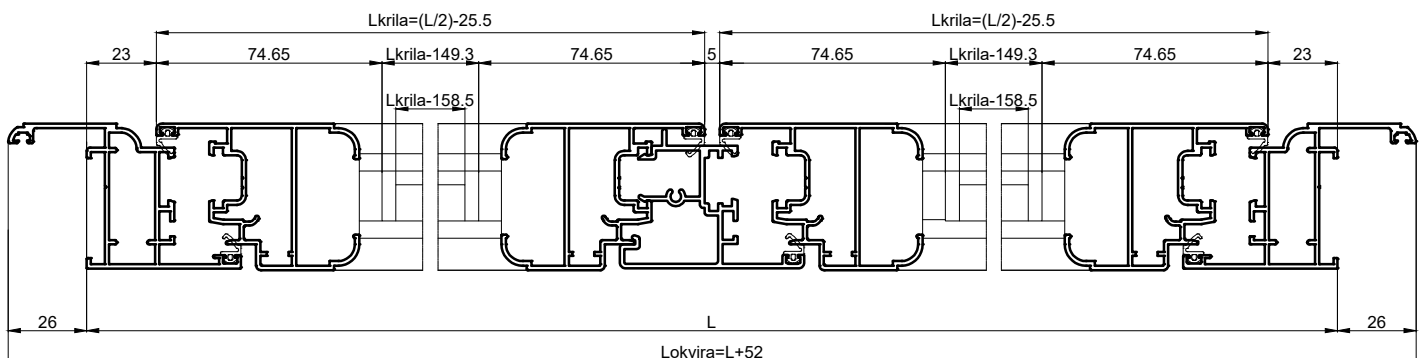
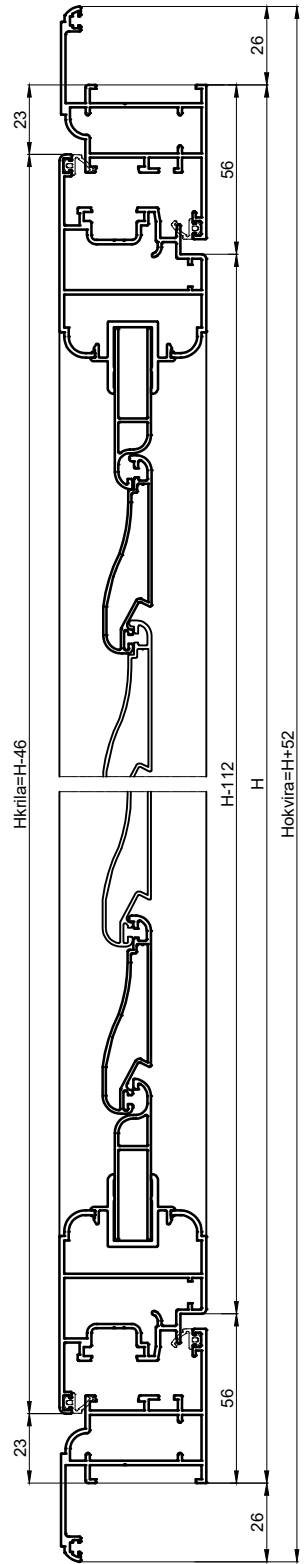
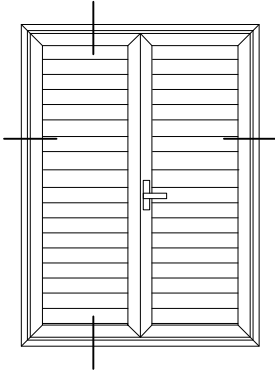

## REZNE LISTE - Trokrilna prozorska grilja

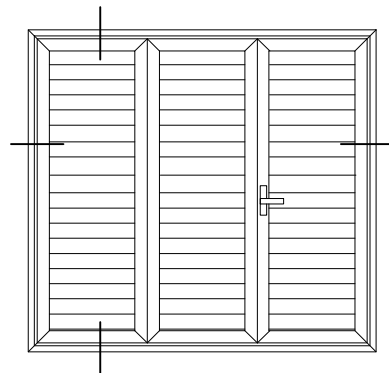

KOD	PROFIL	BR. KOM	REZANJE
PS 15006	OKOMICA OKVIRA	2	H+52
PS 15006	GORNJA VODORAVNICA OKVIRA	1	L+52
PS 15006	DONJA VODORAVNICA OKVIRA	1	L+52
PS 15005	OKOMICA KRILA	6	H-46
PS 15005	VODORAVNICA KRILA	6	Lkrila=L/3-18.7
PS 15007	CENTRALNI PROFIL	2	H-112
PS 15008	NOSAČ POČETNE LAMELE	6	Lkrila-158.5
PS 15003	POČETNA LAMELA	6	Lkrila-158.5
PS 15004	LAMELA	nLU	Lkrila-149.3

nLI - Izračunati broj lamela  
nLU - Usvojeni broj lamela  
H - visina građevinskog otvora  
Hs - visina skraćenja početne lamele

$$nLI = (H - 256) : 55$$

Dobiveni broj lamela zaokružuje se na veći cijeli broj (nLU).

Nakon izračuna radi se korekcija visine početne i krajnje lamele po formuli:

$$Hs = (nLU - nLI) \times 55 / 2$$

\*U katalogu se prikazani kodovi za crnu verziju okova.

Kodovi za bijelu verziju okova su:

ET0361- Ručica, bijela  
ET0458- Mehanizam, bijeli  
GS01004- Ručka, bijela  
GS0121- Baglama, bijela  
R000408- TMS NSUP 9010- Držac grilje, dugi

KOD	OKOVI	BR. KOM	NOTE
G 201	KUTNIK OKVIRA/KRILA	16	
PRA 14	KUTNIK PORAVNANJA KRILA/OKVIRA	16	
GS2273	KAPA ZA CENTRALNI PROFIL GRILJE	2	

KOD	BRTVE/ČEPOVI	BR. KOM	NOTE
PRG05-PR	BRTVA OKVIRA/KRILA	14	4L + 10H

KOD	OKOV I PRIBOR	BR. KOM	NOTE
ET0369	RUČICA, CRNA	3	
ET0376	MEHANIZAM, CRNI	3	H
GS01004	RUČKA, CRNA	1	
GS0121	BAGLAMA, CRNA	9	
GS1314	PRIHVATNIK KRAKUNA	2	
GS1339	DUPLI PRIHVATNIK	2	
GS2111	KRAKUN	4	
GS2114	ZAPINJAČ KRAJNJI	2	
GS2260	SET ZA RUČKU	1	
R000407	TMS NSUP 9005- DRŽAČ GRILJE, DUGI	2	

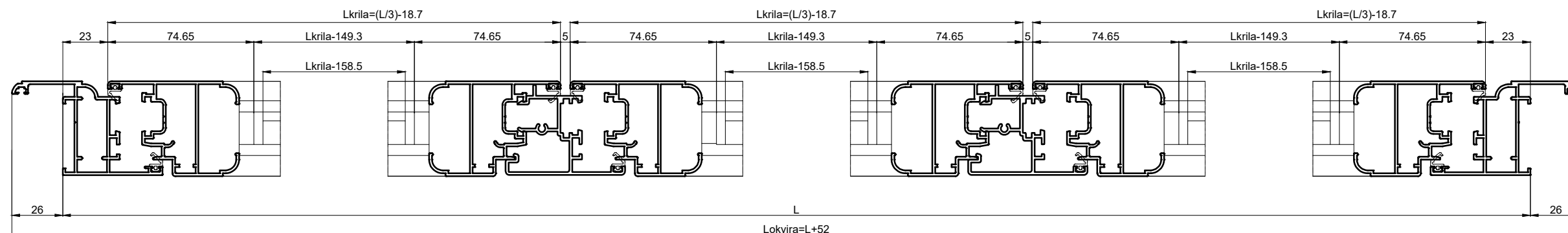
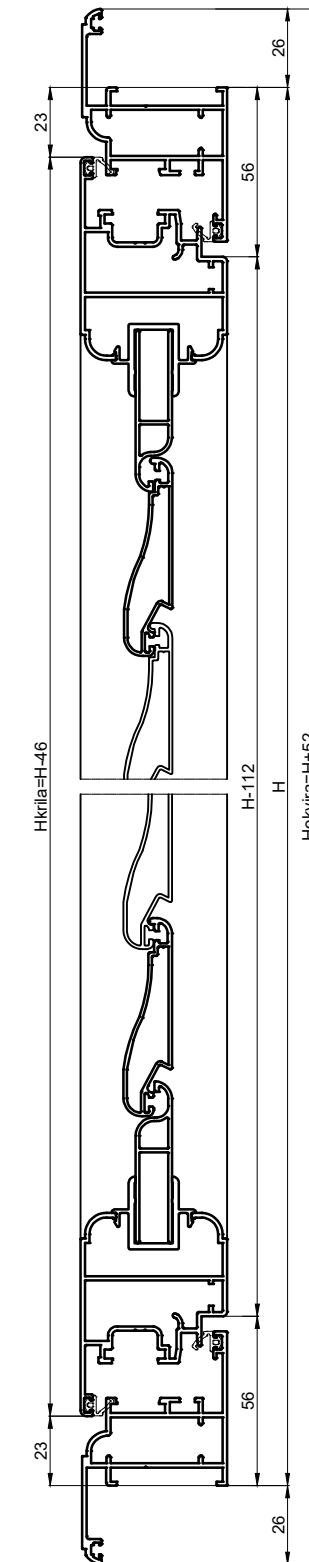

## REZNE LISTE - Cetverokrilna prozorska grilja

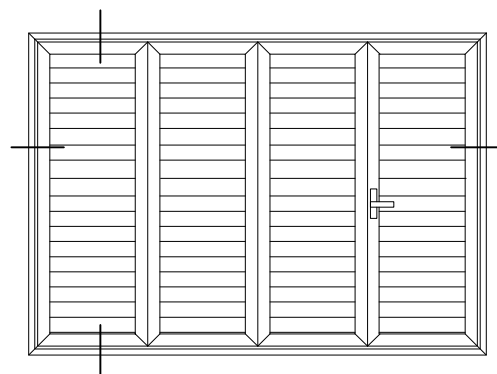

KOD	PROFIL	BR. KOM	REZANJE	KOD	OKOVI	BR. KOM	NOTE
PS 15006	OKOMICA OKVIRA	2	H+52	G 201	KUTNIK OKVIRA/KRILA	20	
PS 15006	GORNJA VODORAVNICA OKVIRA	1	L+52	PRA 14	KUTNIK PORAVNANJA KRILA/OKVIRA	20	
PS 15006	DONJA VODORAVNICA OKVIRA	1	L+52	GS2273	KAPA ZA CENTRALNI PROFIL GRILJE	3	
PS 15005	OKOMICA KRILA	8	H-46				
PS 15005	VODORAVNICA KRILA	8	Lkrila=L/4-15.25				
PS 15007	CENTRALNI PROFIL	3	H-112				
PS 15008	NOSAČ POČETNE LAMELE	8	Lkrila-158.5				
PS 15003	POČETNA LAMELA	8	Lkrila-158.5				
PS 15004	LAMELA	nLU	Lkrila-149.3				

KOD	BRTVE/ČEPOVI	BR. KOM	NOTE
PRG05-PR	BRTVA OKVIRA/KRILA	17	4L + 13H

KOD	OKOV I PRIBOR	BR. KOM	NOTE
ET0369	RUČICA, CRNA	4	
ET0376	MEHANIZAM, CRNI	4	H
GS01004	RUČKA, CRNA	1	
GS0121	BAGLAMA, CRNA	12	
GS1314	PRIHVATNIK KRAKUNA	4	
GS1339	DUPLI PRIHVATNIK	2	
GS2111	KRAKUN	6	
GS2114	ZAPINJAČ KRAJNJI	2	
GS2260	SET ZA RUČKU	1	
R000407	TMS NSUP 9005- DRŽAČ GRILJE, DUGI	2	

nLI - Izračunati broj lamela  
nLU - Usvojeni broj lamela  
H - visina građevinskog otvora  
Hs - visina skraćenja početne lamele

$$nLI=(H-256):55$$

Dobiveni broj lamela zaokružuje se na veći cijeli broj(nLU).

Nakon izračuna radi se korekcija visine početne i krajnje lamele po formuli:

$$Hs=(nLU-nLI) \times 55/2$$

\*U katalogu se prikazani kodovi za crnu verziju okova.

Kodovi za bijelu verziju okova su:

- ET0361- Ručica, bijela
- ET0458- Mehanizam, bijeli
- GS01004- Ručka, bijela
- GS0121- Baglama, bijela
- R000408- TMS NSUP 9010- Držac grilje, dugi

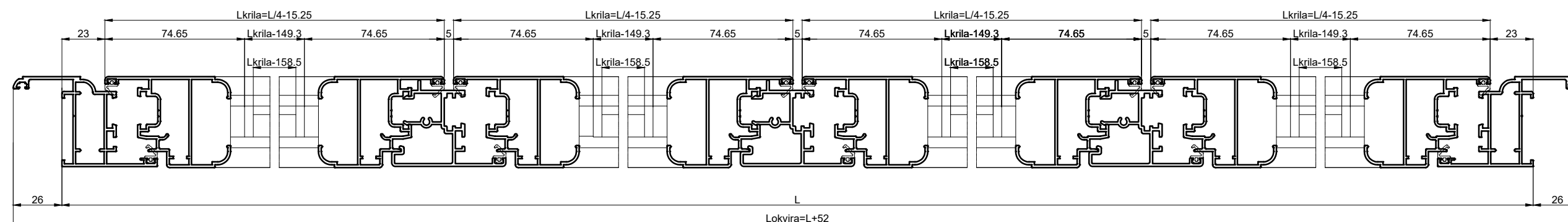
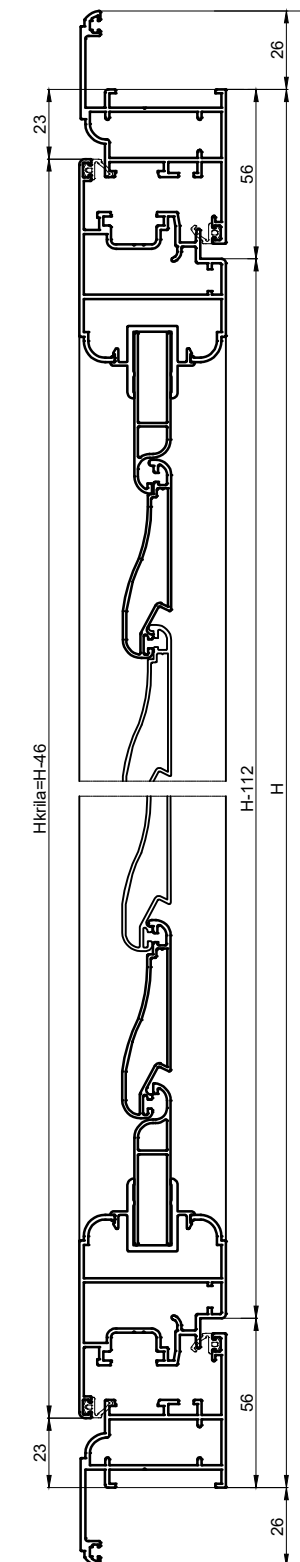

**REZNE LISTE - Jednokrilna balkonska grilja - Uski parapet**

KOD	PROFIL	BR. KOM	REZANJE
PS 15006	OKOMICA OKVIRA	1L 1D	 H+26
PS 15006	GORNJA VODORAVNICA OKVIRA	1	 L+52
PS 15005	OKOMICA KRILA	1L 1D	 H-29
PS 15005	VODORAVNICA KRILA	1	 Lkrila=L-46
PS 15062	PARAPET	2	 Lkrila-92.5
PS 15008	NOSAČ POČETNE LAMELE	4	 Lkrila-158.5
PS 15003	POČETNA LAMELA	4	 Lkrila-158.5
PS 15004	LAMELA	nLU	 Lkrila-149.3

nLI - Izračunati broj lamela  
nLU - Usvojeni broj lamela  
H - visina građevinskog otvora  
Hs - visina skraćenja početne lamele

$$nLI=(H-367.5):55$$

Dobiveni broj lamela zaokružuje se na veći cijeli broj(nLU).

Nakon izračuna radi se korekcija visine početne i krajnje lamele po formuli:

$$Hs=(nLU-nLI) \times 55/2$$

\*U katalogu se prikazani kodovi za crnu verziju okova.

Kodovi za bijelu verziju okova su:

ET0361- Ručica, bijela

ET0458- Mehanizam, bijeli

GS01004- Ručka, bijela

GS0121- Baglama, bijela

R000408- TMS NSUP 9010- Držac grilje, dugi

KOD	OKOVI	BR. KOM	NOTE
G 201	KUTNIK OKVIRA/KRILA	4	
PRA 14	KUTNIK PORAVNANJA KRILA/OKVIRA	4	

KOD	BRTVE/ČEPOVI	BR. KOM	NOTE
PRG05-PR	BRTVA OKVIRA/KRILA	6	2L + 4H

KOD	OKOV I PRIBOR	BR. KOM	NOTE
ET0369	RUČICA, CRNA	2	
ET0376	MEHANIZAM, CRNI	2	H/2
GS01004	RUČKA, CRNA	1	
GS0121	BAGLAMA, CRNA	5	
GS1314	PRIHVATNIK KRAKUNA	2	
GS2114	ZAPINJAČ KRAJNJI	2	
GS2260	SET ZA RUČKU	1	
R000407	TMS NSUP 9005- DRŽAČ GRILJE, DUGI	1	

## REZNE LISTE - Jednokrilna balkonska grilja - Uski parapet

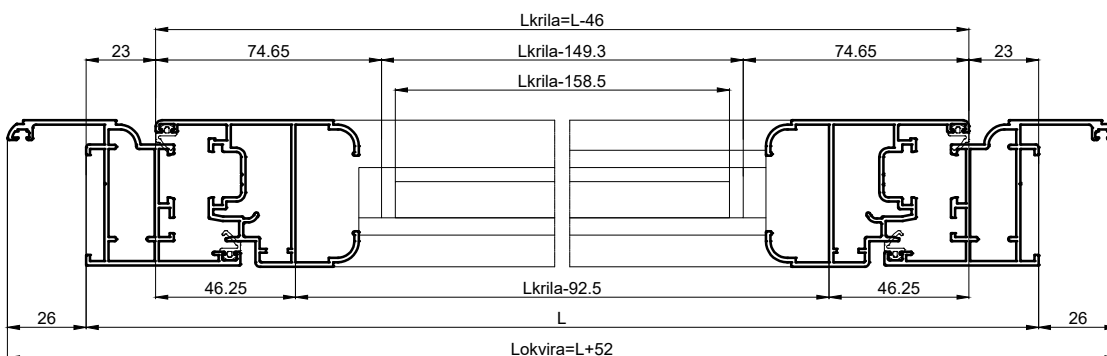
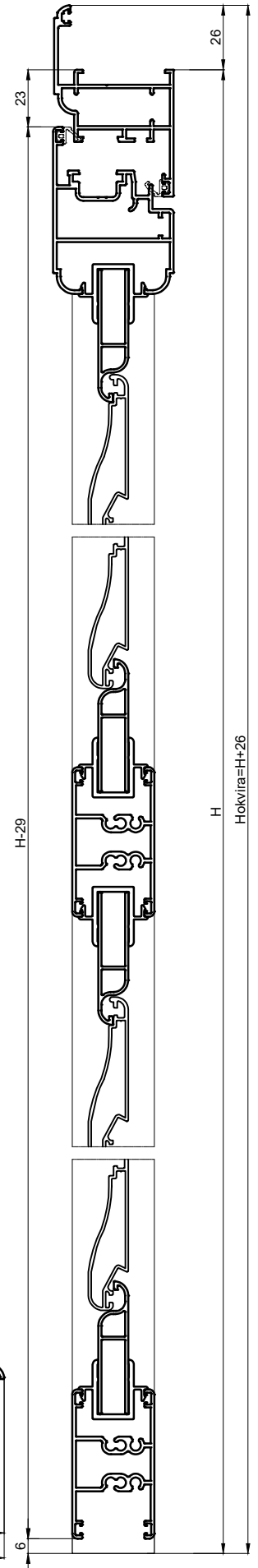
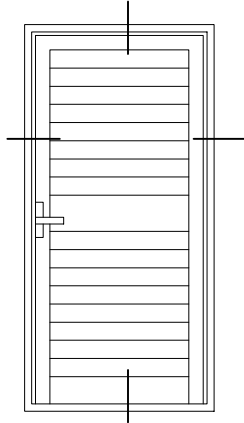

**REZNE LISTE - Dvokrilna balkonska grilja - Uski parapet**

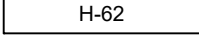
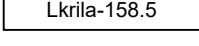
KOD	PROFIL	BR. KOM	REZANJE
PS 15006	OKOMICA OKVIRA	2	
PS 15006	GORNJA VODORAVNICA OKVIRA	1	
PS 15005	OKOMICA KRILA	4	
PS 15005	VODORAVNICA KRILA	2	
PS 15062	PARAPET	4	
PS 15007	CENTRALNI PROFIL	1	
PS 15008	NOSAČ POČETNE LAMELE	8	
PS 15003	POČETNA LAMELA	8	
PS 15004	LAMELA	nLU	

nLI - Izračunati broj lamela  
nLU - Usvojeni broj lamela  
H - visina građevinskog otvora  
Hs - visina skraćenja početne lamele

$$nLI=(H-367.5):55$$

Dobiveni broj lamela zaokružuje se na veći cijeli broj(nLU).

Nakon izračuna radi se korekcija visine početne i krajnje lamele po formuli:

$$Hs=(nLU-nLI) \times 55/2$$

\*U katalogu se prikazani kodovi za crnu verziju okova.

Kodovi za bijelu verziju okova su:

ET0361- Ručica, bijela

ET0458- Mehanizam, bijeli

GS01004- Ručka, bijela

GS0121- Baglama, bijela

R000408- TMS NSUP 9010- Držac grilje, dugi

KOD	OKOVI	BR. KOM	NOTE
G 201	KUTNIK OKVIRA/KRILA	6	
PRA 14	KUTNIK PORAVNANJA KRILA/OKVIRA	6	
GS2273	KAPA ZA CENTRALNI PROFIL GRILJE	1	

KOD	BRTVE/ČEPOVI	BR. KOM	NOTE
PRG05-PR	BRTVA OKVIRA/KRILA	9	2L + 7H

KOD	OKOV I PRIBOR	BR. KOM	NOTE
ET0369	RUČICA, CRNA	4	
ET0376	MEHANIZAM, CRNI	4	H/2
GS01004	RUČKA, CRNA	1	
GS0121	BAGLAMA, CRNA	10	
GS1339	DUPLI PRIHVATNIK	2	
GS2111	KRAKUN	2	
GS2114	ZAPINJAČ KRAJNJI	2	
GS2260	SET ZA RUČKU	1	
R000407	TMS NSUP 9005- DRŽAČ GRILJE, DUGI	2	



REZNE LISTE - Dvokrilna balkonska grilja - Uski parapet

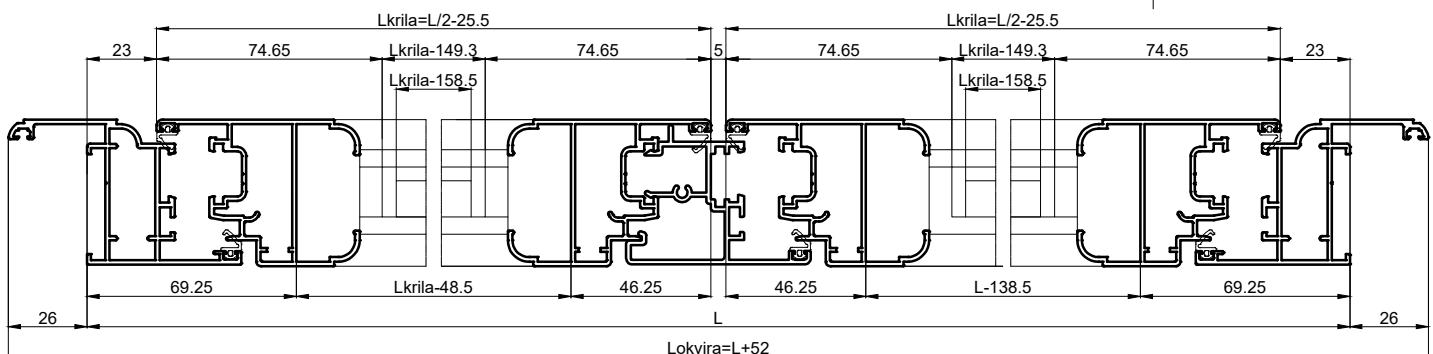
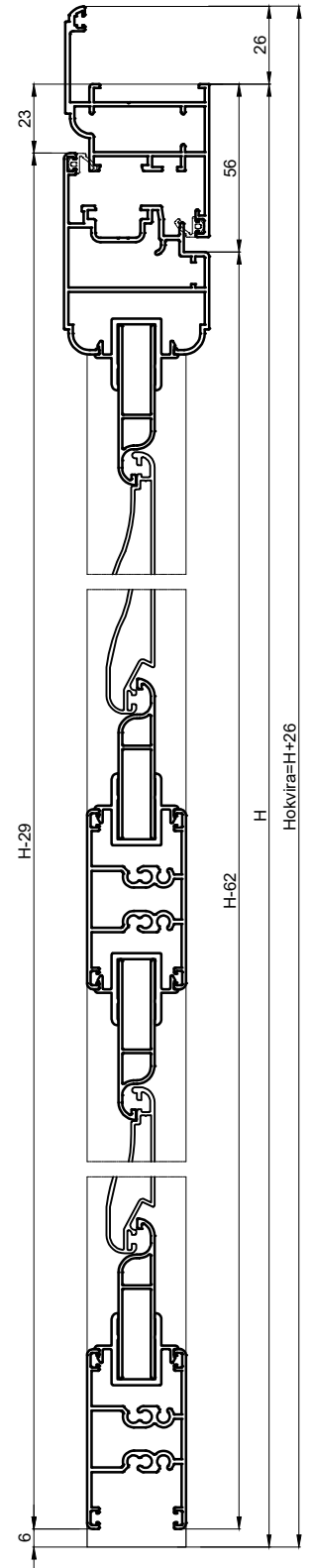
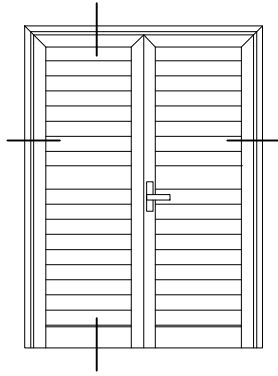

**REZNE LISTE - Jednokrilna balkonska grilja**

KOD	PROFIL	BR. KOM	REZANJE
PS 15006	OKOMICA OKVIRA	2	 H+52
PS 15006	GORNJA VODORAVNICA OKVIRA	1	 L+52
PS 15005	OKOMICA KRILA	2	 H-29
PS 15005	VODORAVNICA KRILA	1	 Lkrila=L-46
PS 15062	PARAPET SREDNJI	1	 Lkrila-92.5
PS 15600	PARAPET DONJI	1	 Lkrila-92.5
PS 15008	NOSAČ POČETNE LAMELE	4	 L-158.5
PS 15003	POČETNA LAMELA	4	 L-158.5
PS 15004	LAMELA	N	 L-149.3

nLI - Izračunati broj lamela  
nLU - Usvojeni broj lamela  
H - visina građevinskog otvora  
Hs - visina skraćenja početne lamele

$$nLI=(H-435.5):55$$

Dobiveni broj lamela zaokružuje se na veći cijeli broj(nLU).

Nakon izračuna radi se korekcija visine početne i krajnje lamele po formuli:

$$Hs=(nLU-nLI) \times 55/2$$

\*U katalogu se prikazani kodovi za crnu verziju okova.

Kodovi za bijelu verziju okova su:

ET0361- Ručica, bijela

ET0458- Mehanizam, bijeli

GS01004- Ručka, bijela

GS0121- Baglama, bijela

R000408- TMS NSUP 9010- Držac grilje, dugi

KOD	OKOVI	BR. KOM	NOTE
G 201	KUTNIK OKVIRA/KRILA	4	
PRA 14	KUTNIK PORAVNANJA KRILA/OKVIRA	4	

KOD	BRTVE/ČEPOVI	BR. KOM	NOTE
PRG05-PR	BRTVA OKVIRA/KRILA	6	2L + 4H

KOD	OKOV I PRIBOR	BR. KOM	NOTE
ET0369	RUČICA, CRNA	2	
ET0376	MEHANIZAM, CRNI	2	H/2
GS01004	RUČKA, CRNA	1	
GS0121	BAGLAMA, CRNA	5	
GS1314	PRIHVATNIK KRAKUNA	2	
GS2114	ZAPINJAČ KRAJNJI	2	
GS2260	SET ZA RUČKU	1	
R000407	TMS NSUP 9005- DRŽAČ GRILJE, DUGI	1	

## REZNE LISTE - Jednokrilna balkonska grilja

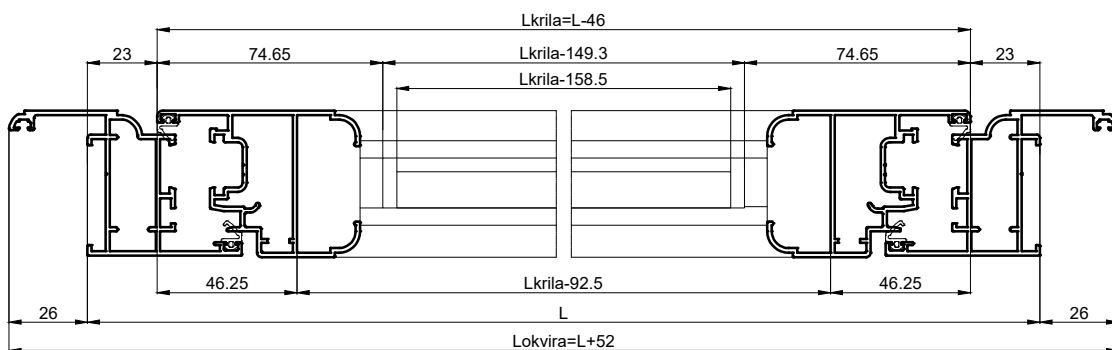
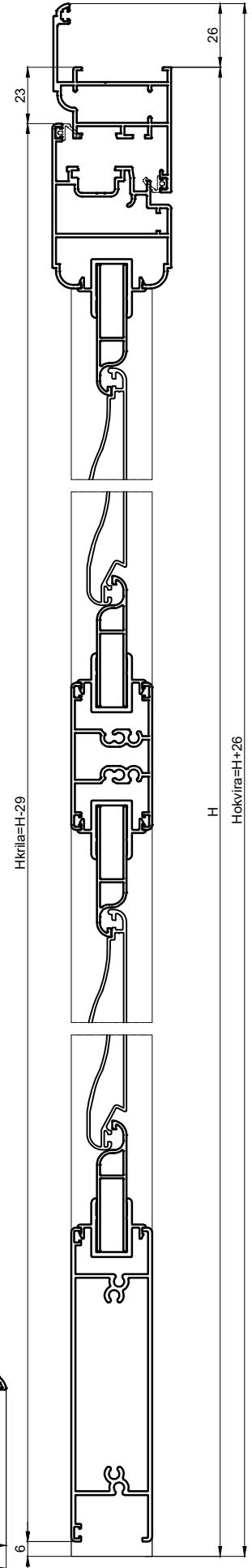
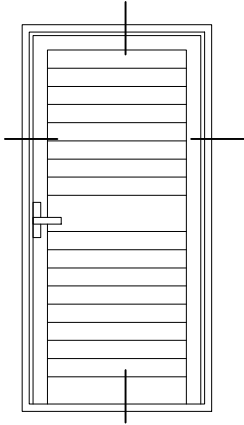

**REZNE LISTE - Dvokrilna balkonska grilja**

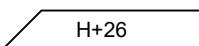
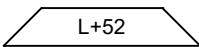
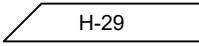
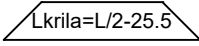
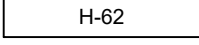
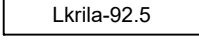
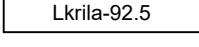
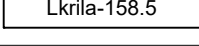
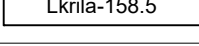
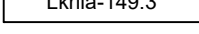
KOD	PROFIL	BR. KOM	REZANJE
PS 15006	OKOMICA OKVIRA	2	
PS 15006	GORNJA VODORAVNICA OKVIRA	1	
PS 15005	OKOMICA KRILA	4	
PS 15005	VODORAVNICA KRILA	2	
PS 15007	CENTRALNI PROFIL	1	
PS 15062	PARAPET SREDNJI	2	
PS 15600	PARAPET DONJI	2	
PS 15061	NOSAČ POČETNE LAMELE	8	
PS 15060	POČETNA LAMELA	8	
PS 01381	LAMELA	N	

nLI - Izračunati broj lamela  
nLU - Usvojeni broj lamela  
H - visina građevinskog otvora  
Hs - visina skraćenja početne lamele

$$nLI=(H-435.5):55$$

Dobiveni broj lamela zaokružuje se na veći cijeli broj(nLU).

Nakon izračuna radi se korekcija visine početne i krajnje lamele po formuli:

$$Hs=(nLU-nLI)x55/2$$

\*U katalogu se prikazani kodovi za crnu verziju okova.

Kodovi za bijelu verziju okova su:

ET0361- Ručica, bijela

ET0458- Mehanizam, bijeli

GS01004- Ručka, bijela

GS0121- Baglama, bijela

R000408- TMS NSUP 9010- Držač grilje, dugi

KOD	OKOVI	BR. KOM	NOTE
G 201	KUTNIK OKVIRA/KRILA	6	
PRA 14	KUTNIK PORAVNANJA KRILA/OKVIRA	6	
GS2273	KAPA ZA CENTRALNI PROFIL GRILJE	1	

KOD	BRTVE/ČEPOVI	BR. KOM	NOTE
PRG05-PR	BRTVA OKVIRA/KRILA	9	2L + 7H

KOD	OKOV I PRIBOR	BR. KOM	NOTE
ET0369	RUČICA, CRNA	4	
ET0376	MEHANIZAM, CRNI	4	H/2
GS01004	RUČKA, CRNA	1	
GS0121	BAGLAMA, CRNA	10	
GS1339	DUPLI PRIHVATNIK	2	
GS2111	KRAKUN	2	
GS2114	ZAPINJAČ KRAJNJI	2	
GS2260	SET ZA RUČKU	1	
R000407	TMS NSUP 9005- DRŽAČ GRILJE, DUGI	2	

REZNE LISTE - Dvokrilna balkonska grilja

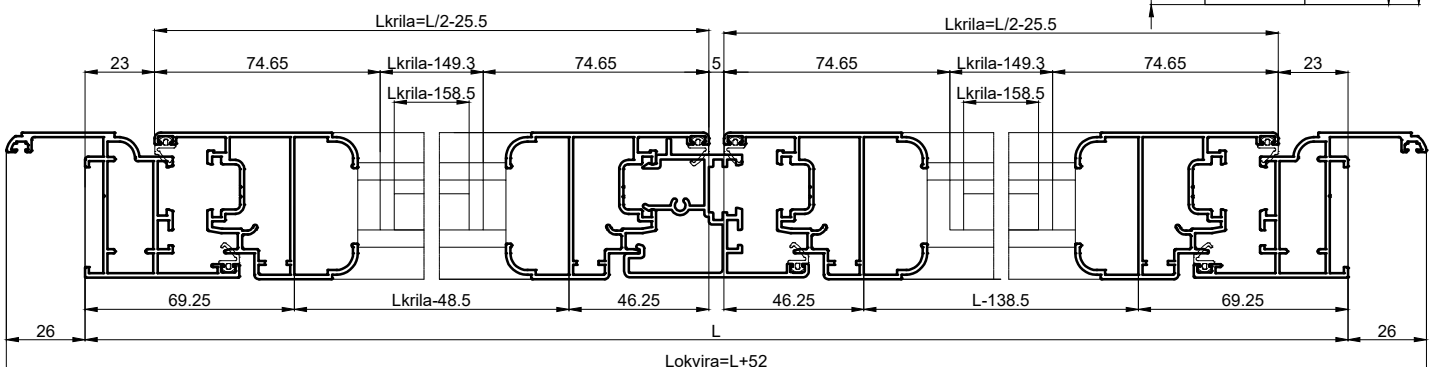
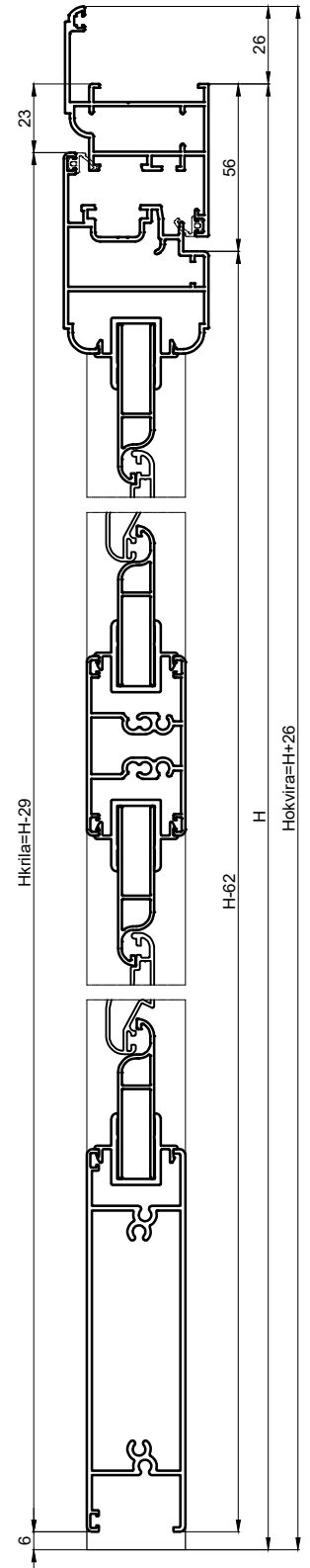
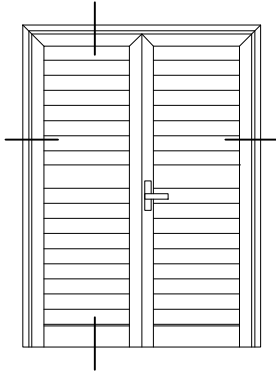

**REZNE LISTE - Jednokrilna balkonska grilja - Široki parapet**

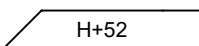
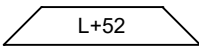
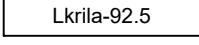
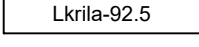
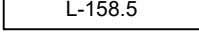
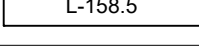
KOD	PROFIL	BR. KOM	REZANJE
PS 15006	OKOMICA OKVIRA	2	 H+52
PS 15006	GORNJA VODORAVNICA OKVIRA	1	 L+52
PS 15005	OKOMICA KRILA	2	 H-29
PS 15005	VODORAVNICA KRILA	1	 Lkrila=L-46
PS 15600	PARAPET SREDNJI	1	 Lkrila-92.5
PS 15600	PARAPET DONJI	1	 Lkrila-92.5
PS 15008	NOSAČ POČETNE LAMELE	4	 L-158.5
PS 15003	POČETNA LAMELA	4	 L-158.5
PS 15004	LAMELA	N	 L-149.3

nLI - Izračunati broj lamela  
 nLU - Usvojeni broj lamela  
 H - visina građevinskog otvora  
 Hs - visina skraćenja početne lamele

$$nLI=(H-503.5):55$$

Dobiveni broj lamela zaokružuje se na veći cijeli broj(nLU).

Nakon izračuna radi se korekcija visine početne i krajnje lamele po formuli:

$$Hs=(nLU-nLI) \times 55/2$$

\*U katalogu se prikazani kodovi za crnu verziju okova.

Kodovi za bijelu verziju okova su:

ET0361- Ručica, bijela

ET0458- Mehanizam, bijeli

GS01004- Ručka, bijela

GS0121- Baglama, bijela

R000408- TMS NSUP 9010- Držac grilje, dugi

KOD	OKOVI	BR. KOM	NOTE
G 201	KUTNIK OKVIRA/KRILA	4	
PRA 14	KUTNIK PORAVNANJA KRILA/OKVIRA	4	

KOD	BRTVE/ČEPOVI	BR. KOM	NOTE
PRG05-PR	BRTVA OKVIRA/KRILA	6	2L + 4H

KOD	OKOV I PRIBOR	BR. KOM	NOTE
ET0369	RUČICA, CRNA	2	
ET0376	MEHANIZAM, CRNI	2	H/2
GS01004	RUČKA, CRNA	1	
GS0121	BAGLAMA, CRNA	5	
GS1314	PRIHVATNIK KRAKUNA	2	
GS2114	ZAPINJAČ KRAJNJI	2	
GS2260	SET ZA RUČKU	1	
R000407	TMS NSUP 9005- DRŽAČ GRILJE, DUGI	1	

REZNE LISTE - Jednokrilna balkonska grilja - Široki parapet

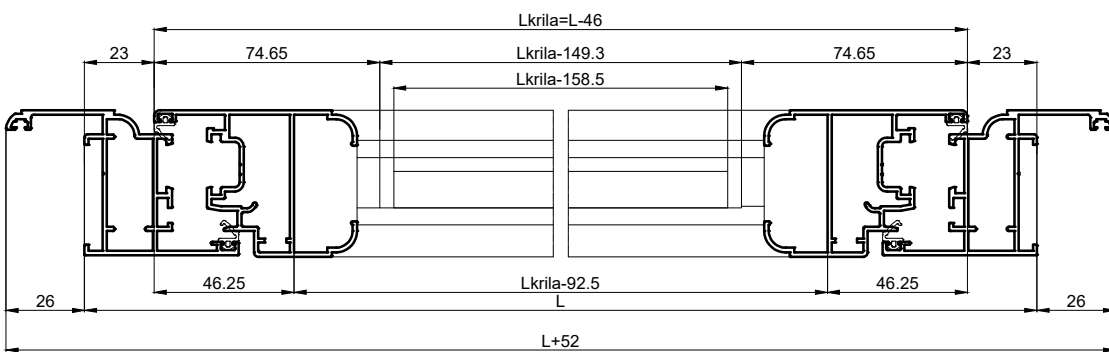
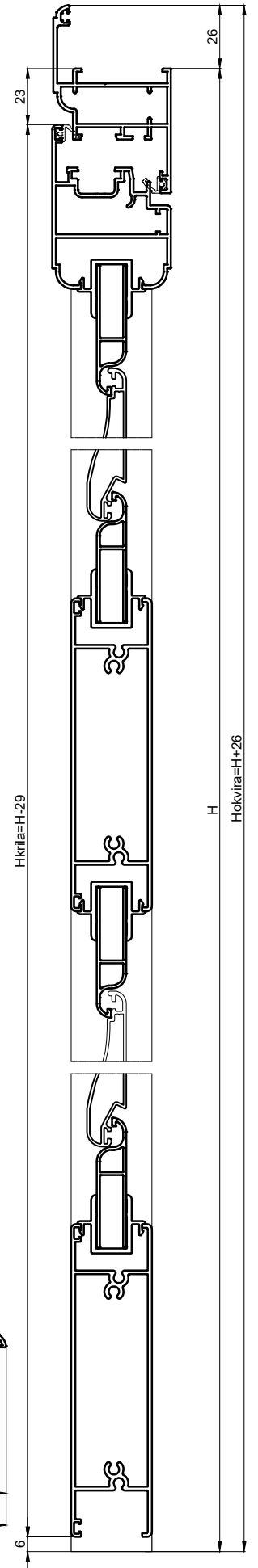
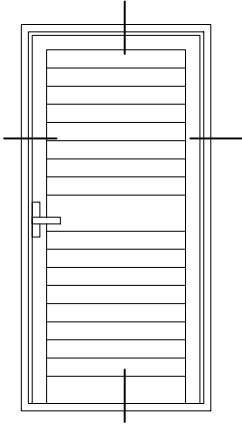

**REZNE LISTE - Dvokrilna balkonska grilja - Široki parapet**

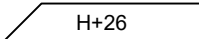
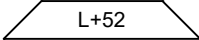
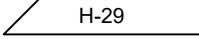
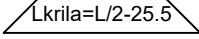
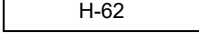
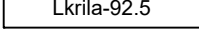
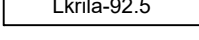
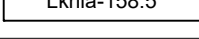
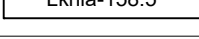
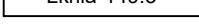
KOD	PROFIL	BR. KOM	REZANJE
PS 15006	OKOMICA OKVIRA	2	
PS 15006	GORNJA VODORAVNICA OKVIRA	1	
PS 15005	OKOMICA KRILA	4	
PS 15005	VODORAVNICA KRILA	2	
PS 15007	CENTRALNI PROFIL	1	
PS 15600	PARAPET SREDNJI	2	
PS 15600	PARAPET DONJI	2	
PS 15061	NOSAČ POČETNE LAMELE	8	
PS 15060	POČETNA LAMELA	8	
PS 01381	LAMELA	N	

nLI - Izračunati broj lamela  
nLU - Usvojeni broj lamela  
H - visina građevinskog otvora  
Hs - visina skraćenja početne lamele

$$nLI=(H-503.5):55$$

Dobiveni broj lamela zaokružuje se na veći cijeli broj(nLU).  
Nakon izračuna radi se korekcija visine početne i krajnje lamele po formuli:

$$Hs=(nLU-nLI) \times 55 / 2$$

\*U katalogu se prikazani kodovi za crnu verziju okova.  
Kodovi za bijelu verziju okova su:  
ET0361- Ručica, bijela  
ET0458- Mehanizam, bijeli  
GS01004- Ručka, bijela  
GS0121- Baglama, bijela  
R000408- TMS NSUP 9010- Držač grilje, dugi

KOD	OKOVI	BR. KOM	NOTE
G 201	KUTNIK OKVIRA/KRILA	6	
PRA 14	KUTNIK PORAVNANJA KRILA	6	
GS2273	KAPA ZA CENTRALNI PROFIL GRILJE	1	

KOD	BRTVE/ČEPOVI	BR. KOM	NOTE
PRG05-PR	BRTVA OKVIRA/KRILA	9	2L + 7H

KOD	OKOV I PRIBOR	BR. KOM	NOTE
ET0369	RUČICA, CRNA	4	
ET0376	MEHANIZAM, CRNI	4	H/2
GS01004	RUČKA, CRNA	1	
GS0121	BAGLAMA, CRNA	10	
GS1339	DUPLI PRIHVATNIK	2	
GS2111	KRAKUN	2	
GS2114	ZAPINJAČ KRAJNJI	2	
GS2260	SET ZA RUČKU	1	
R000407	TMS NSUP 9005- DRŽAČ GRILJE, DUGI	2	



REZNE LISTE - Dvokrilna balkonska grilja - Široki parapet

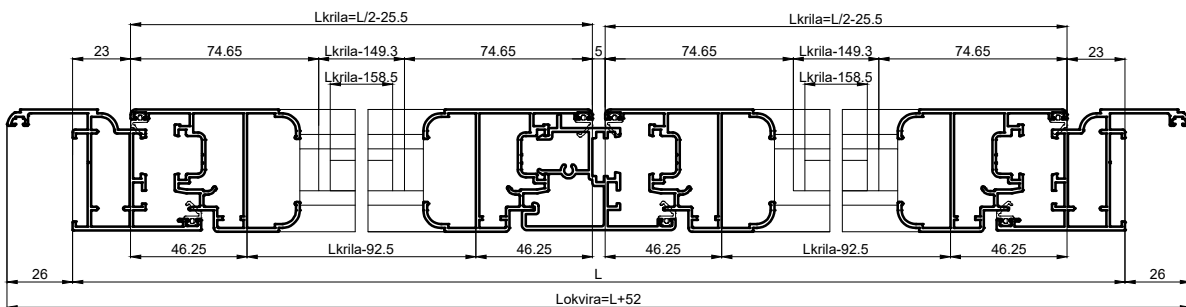
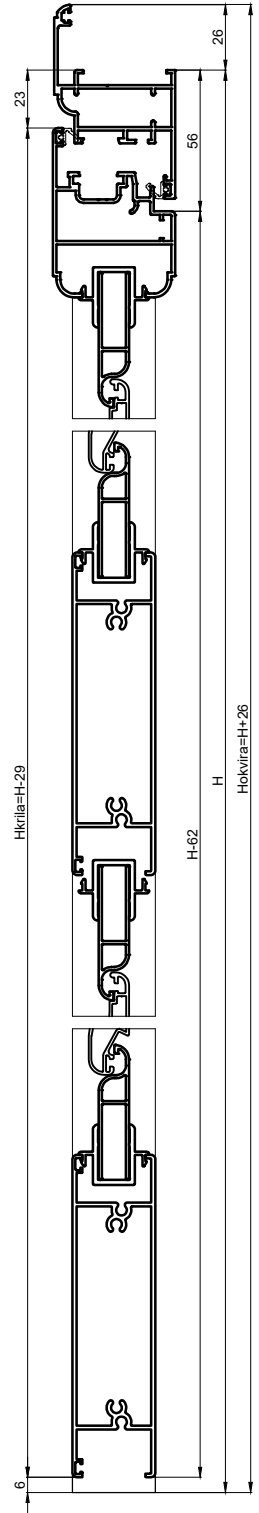
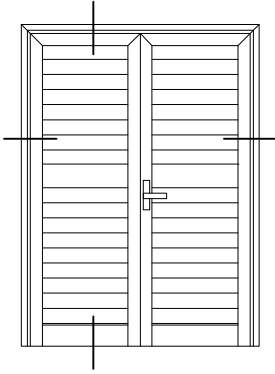

## REZNE LISTE - Trokrilna balkonska grilja - Široki parapet

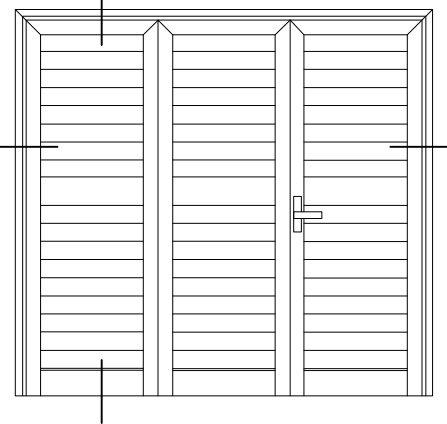

KOD	PROFIL	BR. KOM	REZANJE
PS 15006	OKOMICA OKVIRA	2	H+26
PS 15006	GORNJA VODORAVNICA OKVIRA	1	L+52
PS 15005	OKOMICA KRILA	6	H-29
PS 15005	VODORAVNICA KRILA	3	Lkrila=L/3-18.7
PS 15007	CENTRALNI PROFIL	2	H-62
PS 15600	PARAPET SREDNJI	3	Lkrila-92.5
PS 15600	PARAPET DONJI	3	Lkrila-92.5
PS 15061	NOSAČ POČETNE LAMELE	12	Lkrila-158.5
PS 15060	POČETNA LAMELA	12	Lkrila-158.5
PS 01381	LAMELA	N	Lkrila-149.3

nLI - Izračunati broj lamela  
 nLU - Usvojeni broj lamela  
 H - visina građevinskog otvora  
 Hs - visina skraćenja početne lamele

$$nLI = (H - 503.5) : 55$$

Dobiveni broj lamela zaokružuje se na veći cijeli broj (nLU).

Nakon izračuna radi se korekcija visine početne i krajnje lamele po formuli:

$$Hs = (nLU - nLI) \times 55 / 2$$

\*U katalogu se prikazani kodovi za crnu verziju okova.  
 Kodovi bijelih komponenti su:

KOD	OKOVI	BR. KOM	NOTE
G 201	KUTNIK OKVIRA/KRILA	8	
PRA 14	KUTNIK PORAVNANJA KRILA/OKVIRA	8	
GS2273	KAPA ZA CENTRALNI PROFIL GRILJE	2	

KOD	BRTVE/ČEPOVI	BR. KOM	NOTE
PRG05-PR	BRTVA OKVIRA/KRILA	12	2L + 10H

KOD	OKOV I PRIBOR	BR. KOM	NOTE
ET0369	RUČICA, CRNA	6	
ET0376	MEHANIZAM, CRNI	6	H/2
GS01004	RUČKA, CRNA	1	
GS0121	BAGLAMA, CRNA	15	
GS1314	PRIHVATNIK KRAKUNA	2	
GS1339	DUPLI PRIHVATNIK	2	
GS2111	KRAKUN	4	
GS2114	ZAPINJAČ KRAJNJI	2	
GS2260	SET ZA RUČKU	1	
R000407	TMS NSUP 9005- DRŽAČ GRILJE, DUGI	2	

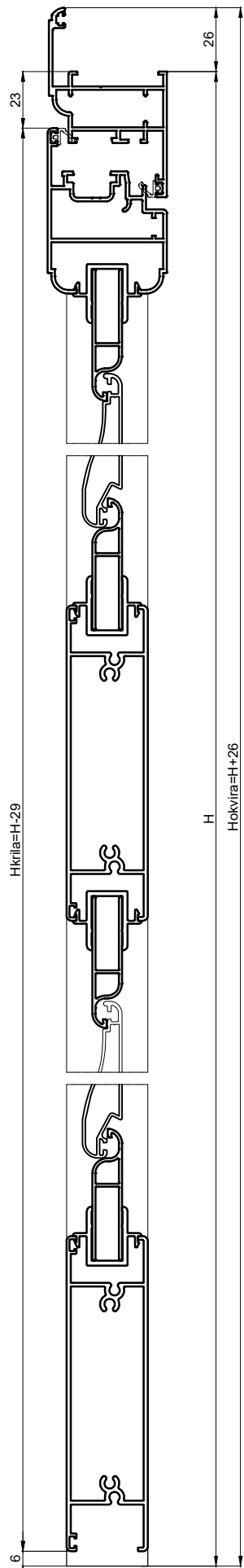
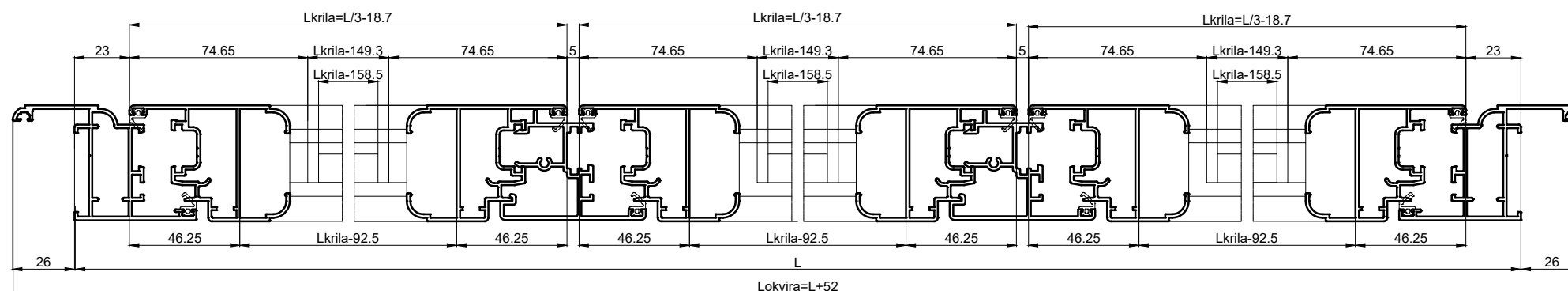

## REZNE LISTE - Cetverokrilna balkonska grilja - Široki parapet

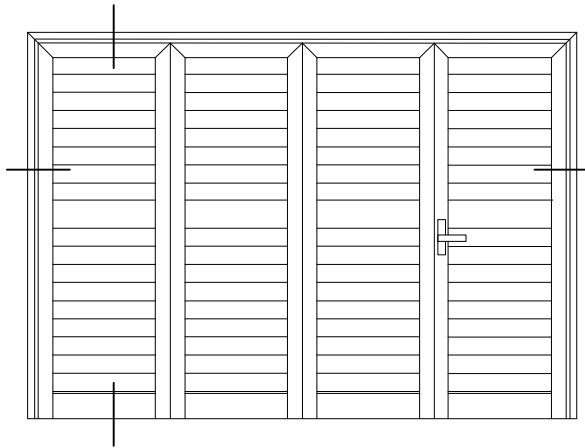

KOD	PROFIL	BR. KOM	REZANJE
PS 15006	OKOMICA OKVIRA	2	H+26
PS 15006	GORNJA VODORAVNICA OKVIRA	1	L+52
PS 15005	OKOMICA KRILA	8	H-29
PS 15005	VODORAVNICA KRILA	4	Lkrila=L/4-15.25
PS 15007	CENTRALNI PROFIL	3	H-62
PS 15600	PARAPET SREDNJI	4	Lkrila-92.5
PS 15600	PARAPET DONJI	4	Lkrila-92.5
PS 15061	NOSAČ POČETNE LAMELE	16	Lkrila-158.5
PS 15060	POČETNA LAMELA	16	Lkrila-158.5
PS 01381	LAMELA	N	Lkrila-149.3

nLI - Izračunati broj lamela  
 nLU - Usvojeni broj lamela  
 H - visina građevinskog otvora  
 Hs - visina skraćanja početne lamele

$$nLI = (H - 503.5) : 55$$

Dobiveni broj lamela zaokružuje se na veći cijeli broj (nLU).

Nakon izračuna radi se korekcija visine početne i krajnje lamele po formuli:

$$Hs = (nLU - nLI) \times 55 / 2$$

\*U katalogu se prikazani kodovi za crnu verziju okova.

Kodovi za bijelu verziju okova su:

ET0361- Ručica, bijela

ET0458- Mehanizam, bijeli

GS01004- Ručka, bijela

GS0121- Baglama, bijela

R000408- TMS NSUP 9010- Držač grilje, dugi

KOD	OKOVI	BR. KOM	NOTE
G 201	KUTNIK OKVIRA/KRILA	10	
PRA 14	KUTNIK PORAVNANJA KRILA/OKVIRA	10	
GS2273	KAPA ZA CENTRALNI PROFIL GRILJE	3	

KOD	BRTVE/ČEPOVI	BR. KOM	NOTE
PRG05-PR	BRTVA OKVIRA/KRILA	15	2L + 13H

KOD	OKOV I PRIBOR	BR. KOM	NOTE
ET0369	RUČICA, CRNA	8	
ET0376	MEHANIZAM, CRNI	8	H/2
GS01004	RUČKA, CRNA	1	
GS0121	BAGLAMA, CRNA	20	
GS1314	PRIHVATNIK KRAKUNA	4	
GS1339	DUPLI PRIHVATNIK	2	
GS2111	KRAKUN	6	
GS2114	ZAPINJAČ KRAJNI	2	
GS2260	SET ZA RUČKU	1	
R000407	TMS NSUP 9005- DRŽAČ GRILJE, DUGI	2	

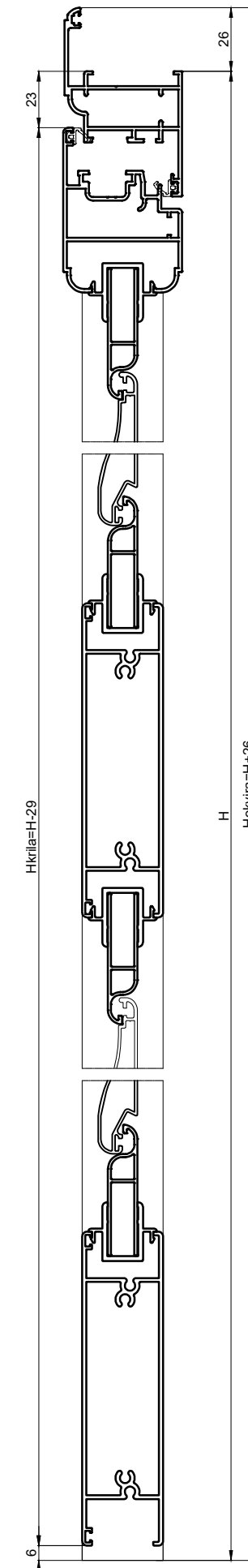
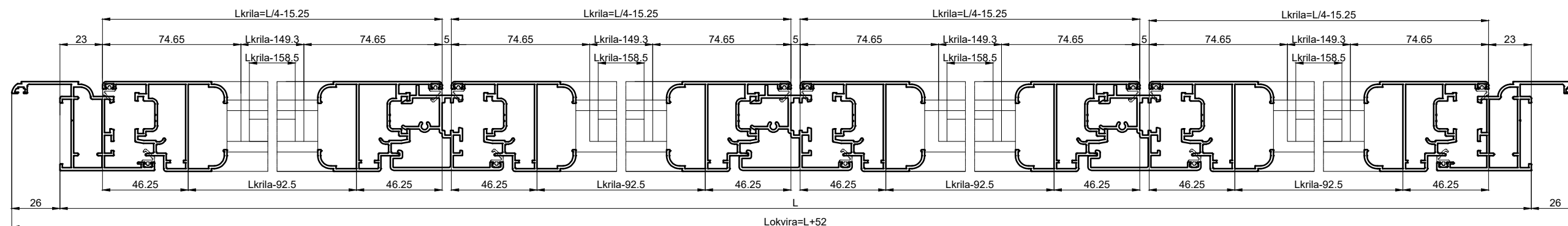

**REZNE LISTE - Jednokrilna prozorska grilja**

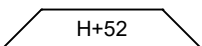
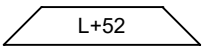
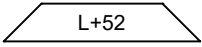
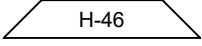
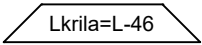
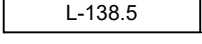
KOD	PROFIL	BR. KOM	REZANJE
PS 15006	OKOMICA OKVIRA	2	
PS 15006	GORNJA VODORAVNICA OKVIRA	1	
PS 15006	DONJA VODORAVNICA OKVIRA	1	
PS 15005	OKOMICA KRILA	2	
PS 15005	VODORAVNICA KRILA	2	
PS 14718	ALUMINIJSKA DASKA	2	

KOD	OKOVI	BR. KOM	NOTE
G 201	KUTNIK OKVIRA/KRILA	8	
PRA 14	KUTNIK PORAVNANJA KRILA/OKVIRA	8	

KOD	BRTVE/ČEPOVI	BR. KOM	NOTE
PRG05-PR	BRTVA OKVIRA/KRILA	8	4L + 4H
PRG14	BRTVA ALUMINIJSKE DASKE	4	2L + 2H
PRG17	BRTVA ALUMINIJSKE DASKE	4	2L + 2H

KOD	OKOV I PRIBOR	BR. KOM	NOTE
ET0369	RUČICA, CRNA	1	
ET0376	MEHANIZAM, CRNI	1	H
GS01004	RUČKA, CRNA	1	
GS0121	BAGLAMA, CRNA	3	
GS1314	PRIHVATNIK KRAKUNA	2	
GS2114	ZAPINJAČ KRAJNJI	2	
GS2260	SET ZA RUČKU	1	
R000407	TMS NSUP 9005- DRŽAČ GRILJE, DUGI	1	

\*U katalogu se prikazani kodovi za crnu verziju okova.

Kodovi za bijelu verziju okova su:

ET0361- Ručica, bijela

ET0458- Mehanizam, bijeli

GS01004- Ručka, bijela

GS0121- Baglama, bijela

R000408- TMS NSUP 9010- Držač grilje, dugi

REZNE LISTE - Jednokrilna prozorska grilja

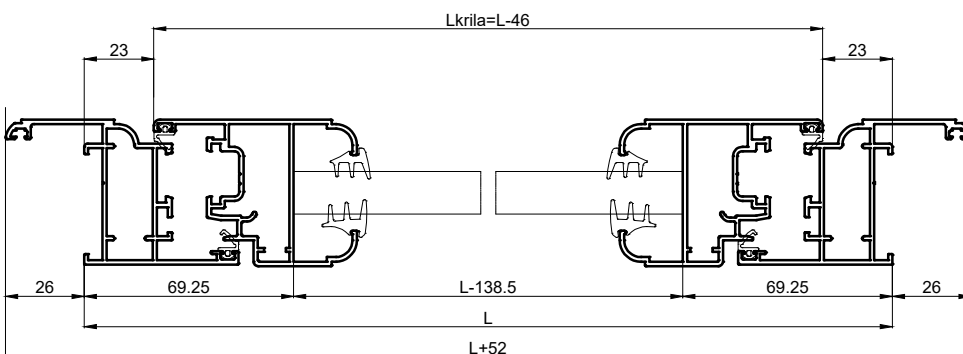
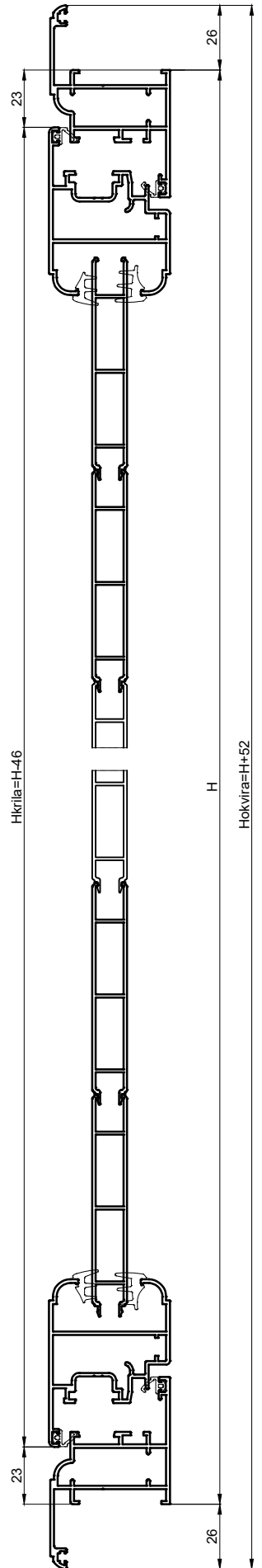
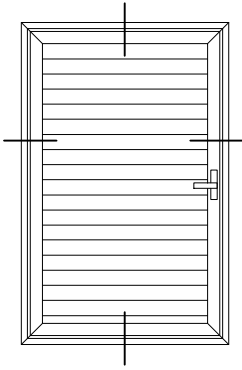

**REZNE LISTE - Jednokrilna prozorska grilja**

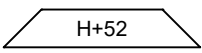
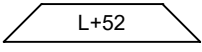
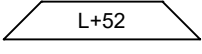
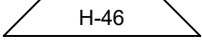
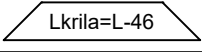
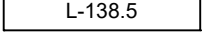
KOD	PROFIL	BR. KOM	REZANJE
PS 15006	OKOMICA OKVIRA	2	 H+52
PS 15006	GORNJA VODORAVNICA OKVIRA	1	 L+52
PS 15006	DONJA VODORAVNICA OKVIRA	1	 L+52
PS 15005	OKOMICA KRILA	2	 H-46
PS 15005	VODORAVNICA KRILA	2	 Lkrila=L-46
PS 14718	ALUMINIJSKA DASKA	2	 L-138.5

KOD	OKOVI	BR. KOM	NOTE
G 201	KUTNIK OKVIRA/KRILA	8	
PRA 14	KUTNIK PORAVNANJA KRILA/OKVIRA	8	

KOD	BRTVE/ČEPOVI	BR. KOM	NOTE
PRG05-PR	BRTVA OKVIRA/KRILA	8	4L + 4H
PRG14	BRTVA ALUMINIJSKE DASKE	4	2L + 2H
PRG17	BRTVA ALUMINIJSKE DASKE	4	2L + 2H

KOD	OKOV I PRIBOR	BR. KOM	NOTE
ET0369	RUČICA, CRNA	1	
ET0376	MEHANIZAM, CRNI	1	H
GS01004	RUČKA, CRNA	1	
GS0121	BAGLAMA, CRNA	3	
GS1314	PRIHVATNIK KRAKUNA	2	
GS2114	ZAPINJAČ KRAJNJI	2	
GS2260	SET ZA RUČKU	1	
R000407	TMS NSUP 9005- DRŽAČ GRILJE, DUGI	1	

\*U katalogu se prikazani kodovi za crnu verziju okova.

Kodovi za bijelu verziju okova su:

ET0361- Ručica, bijela

ET0458- Mehanizam, bijeli

GS01004- Ručka, bijela

GS0121- Baglama, bijela

R000408- TMS NSUP 9010- Držač grilje, dugi

REZNE LISTE - Jednokrilna prozorska grilja

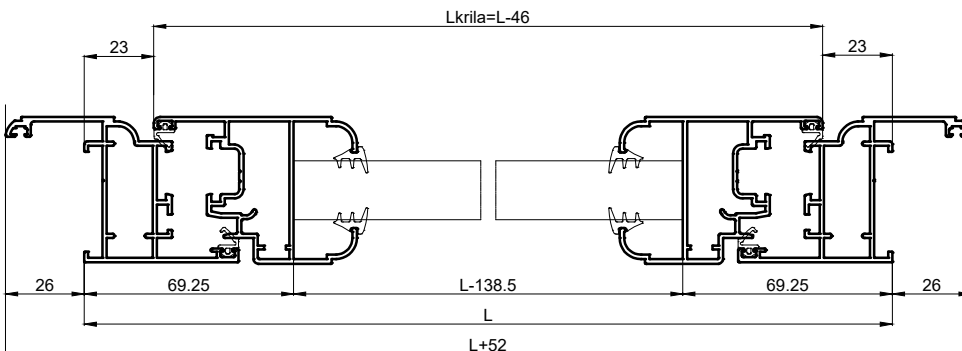
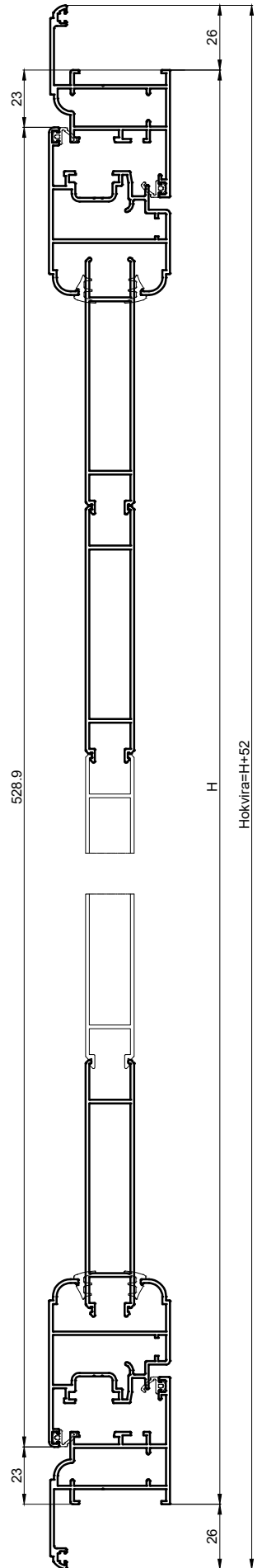
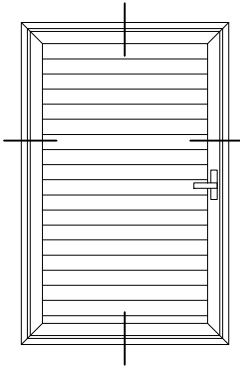

OBRADA NA PROFILU KRILA

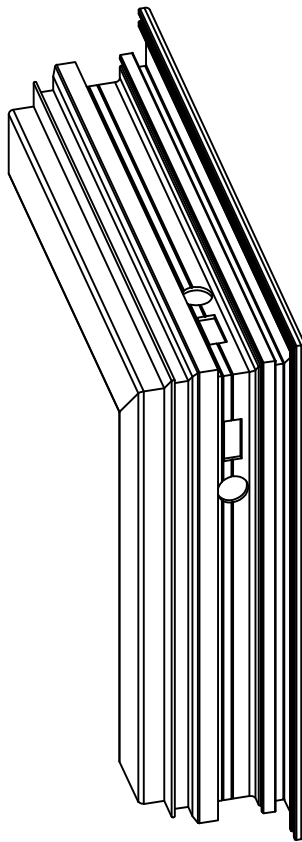



## Obrada na profilu PS15005 za montiranje kutnika G201

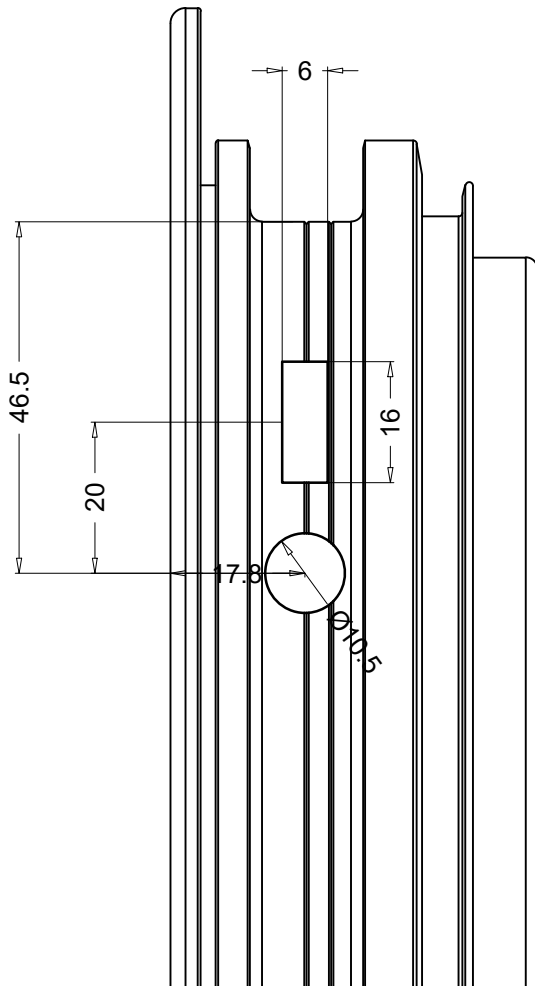
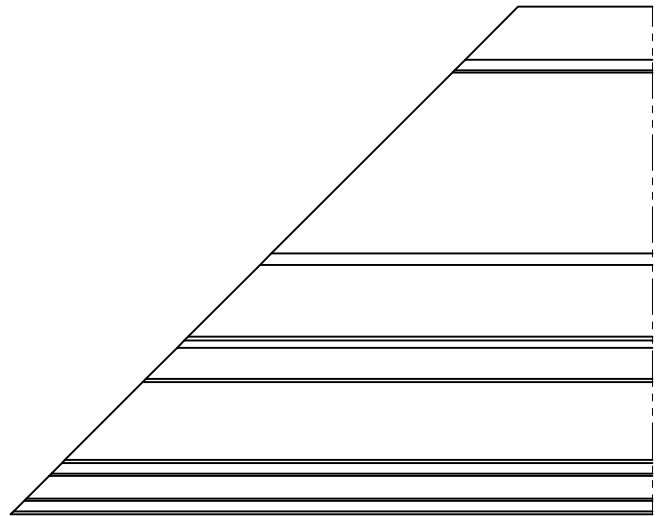
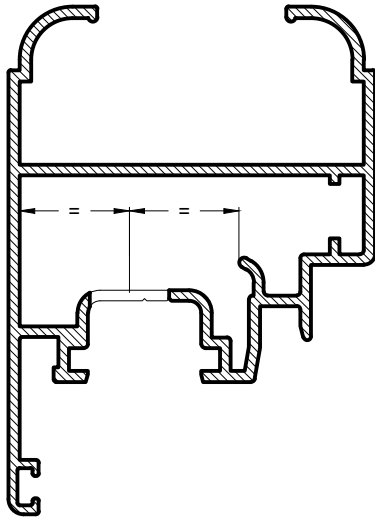

Obrada na profilu PS15005 za montažu ručke

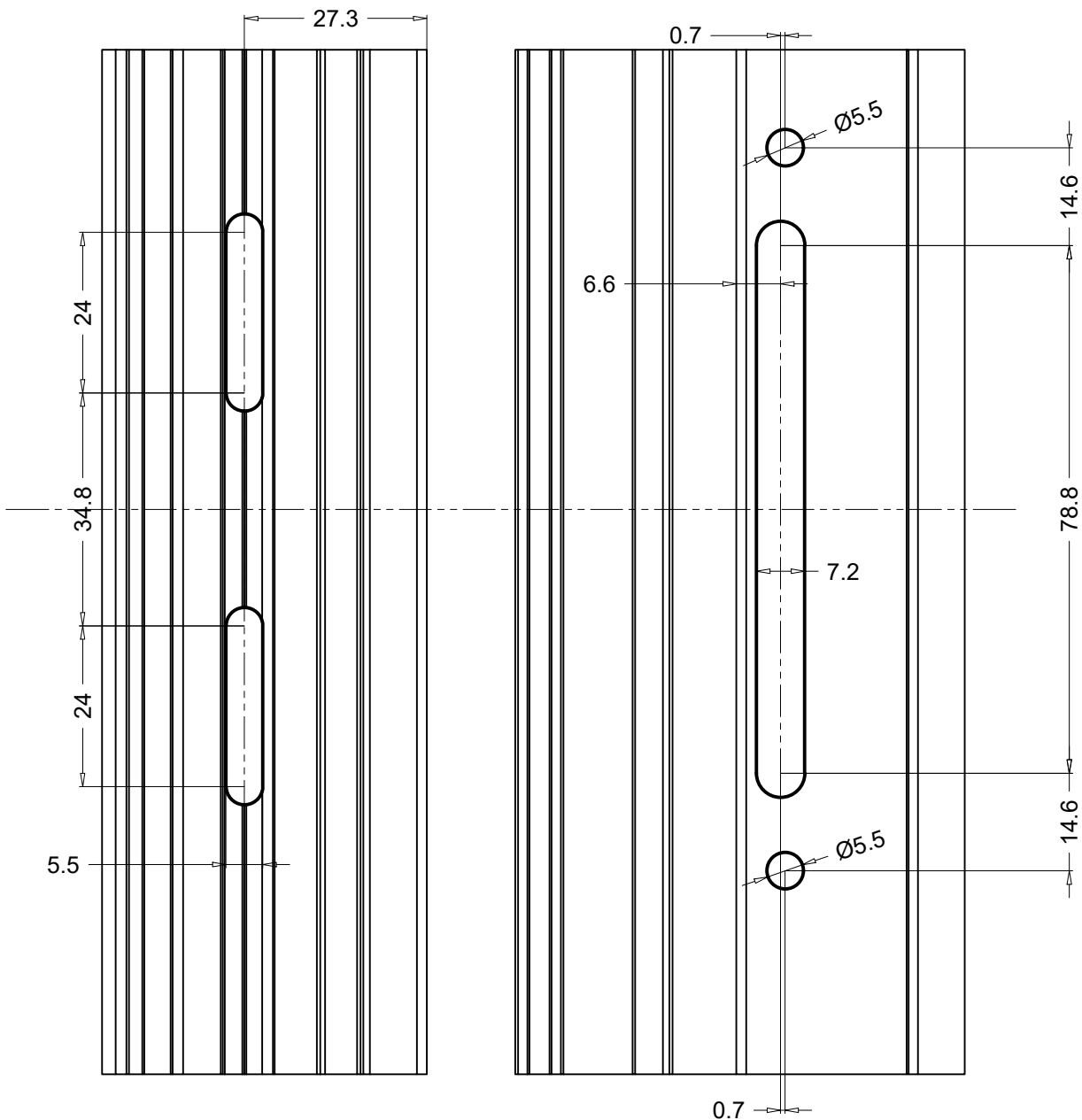
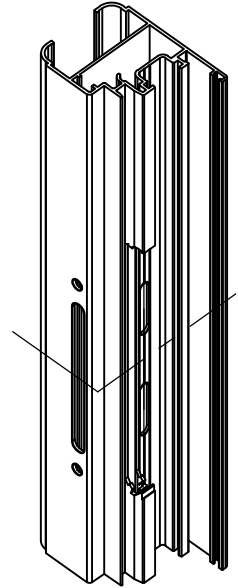
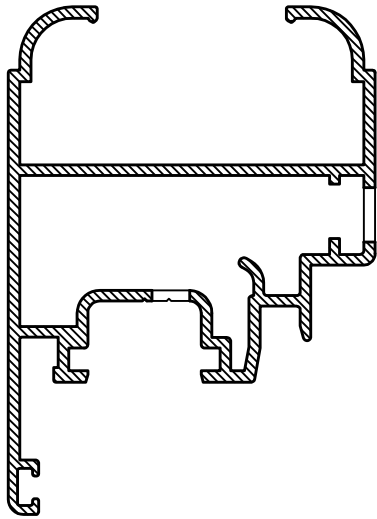

OBRADE NA PROFILU OKVIRA

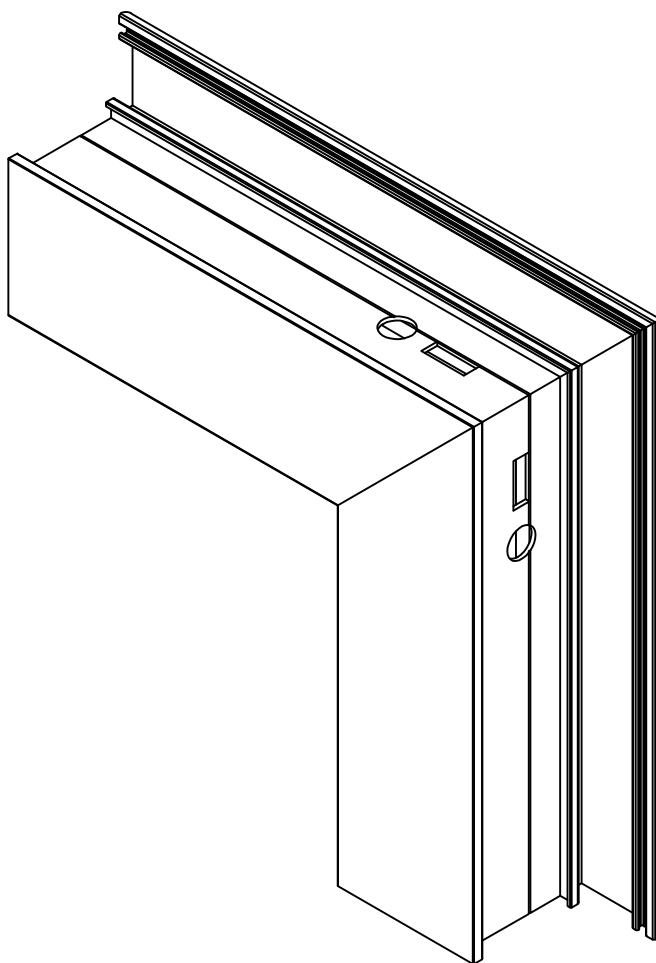

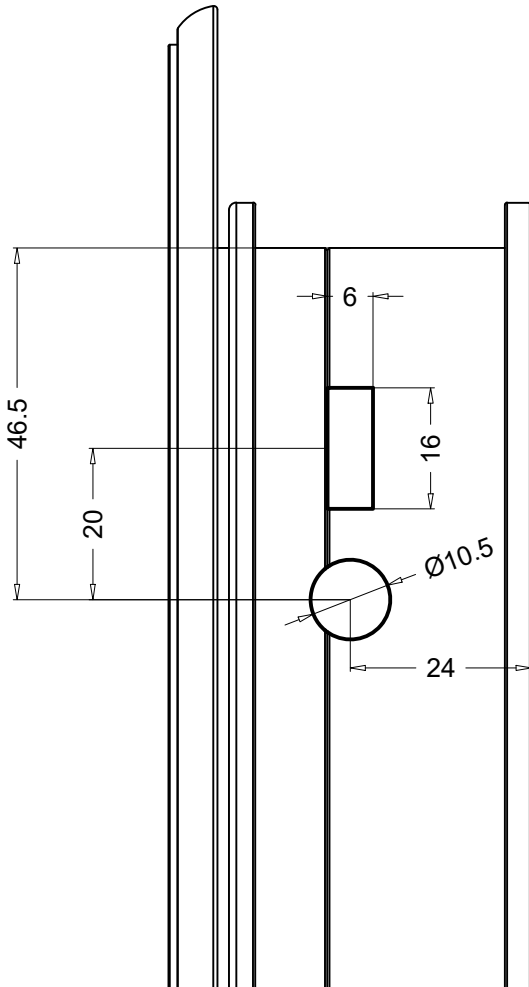
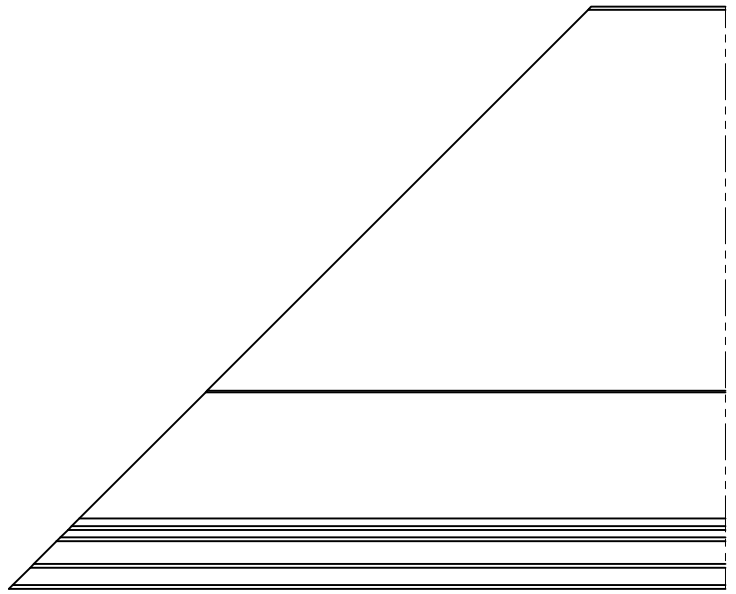
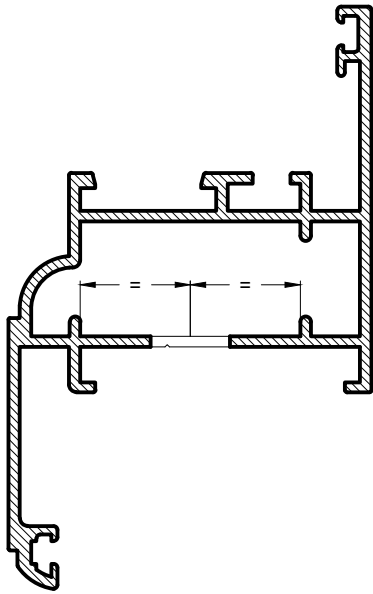



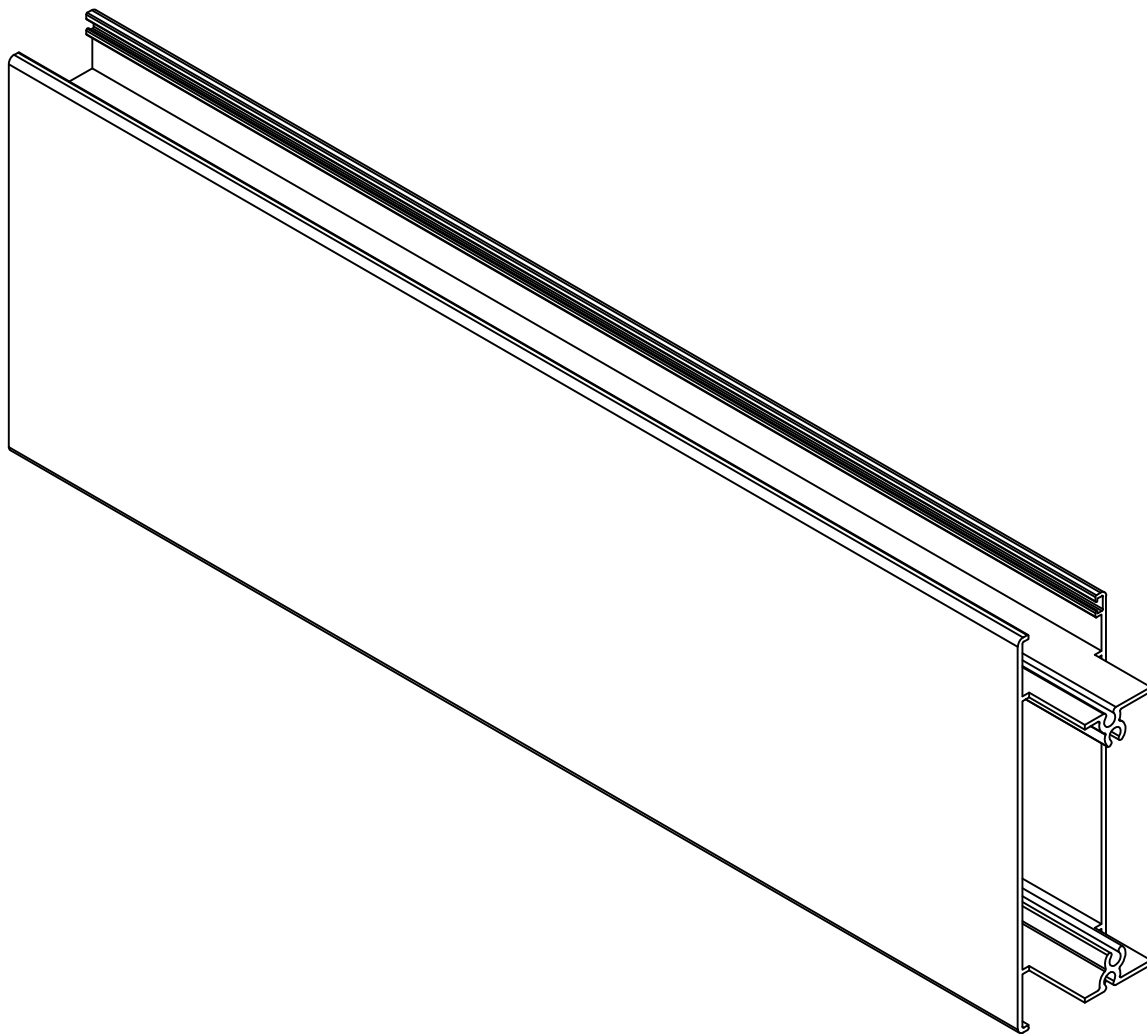

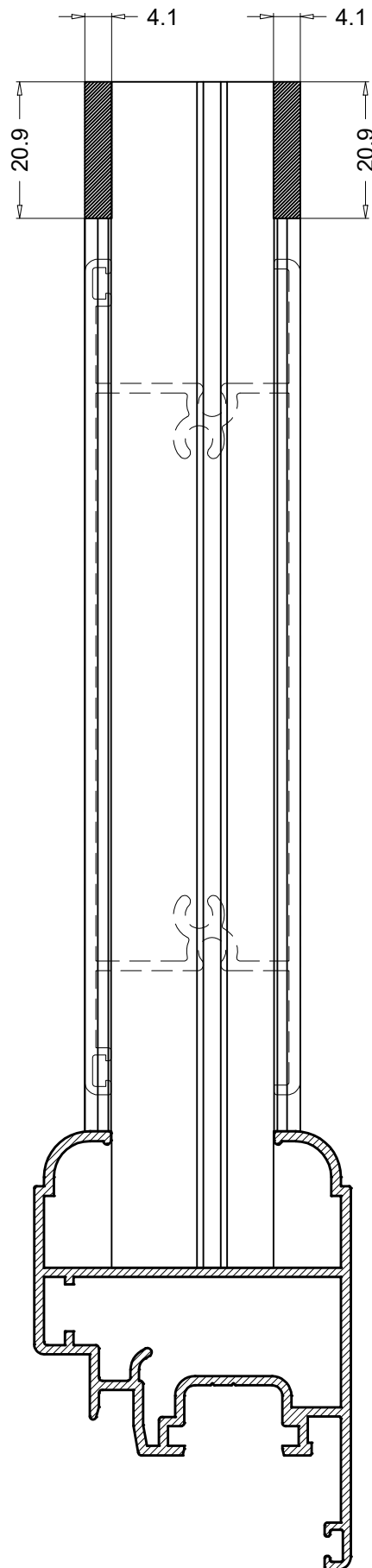

## OBRABE NA PROFILU PARAPETA





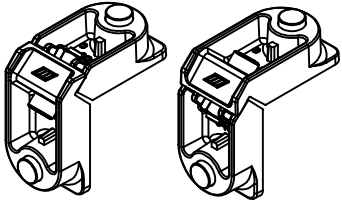
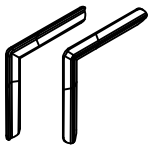



Obrade na profilu PS15600 za spajanje s krilom PS15005



**Okovi**

Code Kod	Section Presjek	Description Opis	Box Quantity Količina/pak.					Material Materijal				
PRG05-PR		UDARNA EPDM BRTVA	200					EPDM				
			E50	E50tt	PR65tt	PE85tt	PS15					
10469		BRTVA LAMELE GRILJE	-					EPDM				
												PS15
G201		Glavni kutnik krila 0409 28.5 x 14.5 mm						Aluminijski odlivak				
												PS15
PRA14		Kutnik poravnanja INOX						Nehrdajući čelik				
												PS15
GS0121-B GS0121-C		Baglama,bijela/crna						-				
												PS15
GS2273		Čep štulpa						EPDM				
												PS15
ET0369 ET0361		Ručica-crna Ručica-bijela						-				
												PS15
GS01004-B GS01004-C		Ručka,bijela/crna						-				
												PS15

**Okovi**

Code Kod	Section Presjek	Description Opis	Box Quantity Količina/pak.	Material Materijal
ET0376 ET0458		Mehanizam crni Mehanizam bijeli	-	-
				PS15
GS1339		Dupli prihvatnik	-	-
				PS15
GS2111		Krakuni	-	-
				PS15
GS2114		Zapinjač	-	-
				PS15
GS2260		Set za ručku	-	-
				PS15
R000407 R000408		TMS NSUP 9005 - Držač grilje TMS NSUP 9010 - Držač grilje	-	-
				PS15



## Napomene



Emerus d.o.o. | A. von Humboldta 4B | 10000 Zagreb | Hrvatska | Tel: +385 1 2099 195

Emerus d.o.o. | Knešpolje b.b. | 88220 Široki Brijeg | Bosna i Hercegovina | Tel: +387 39 701 240

[www.emerus.eu](http://www.emerus.eu)

[info@emerus.eu](mailto:info@emerus.eu)

